

USER'S MANUAL

SONALOK_7S-PV1-2EN

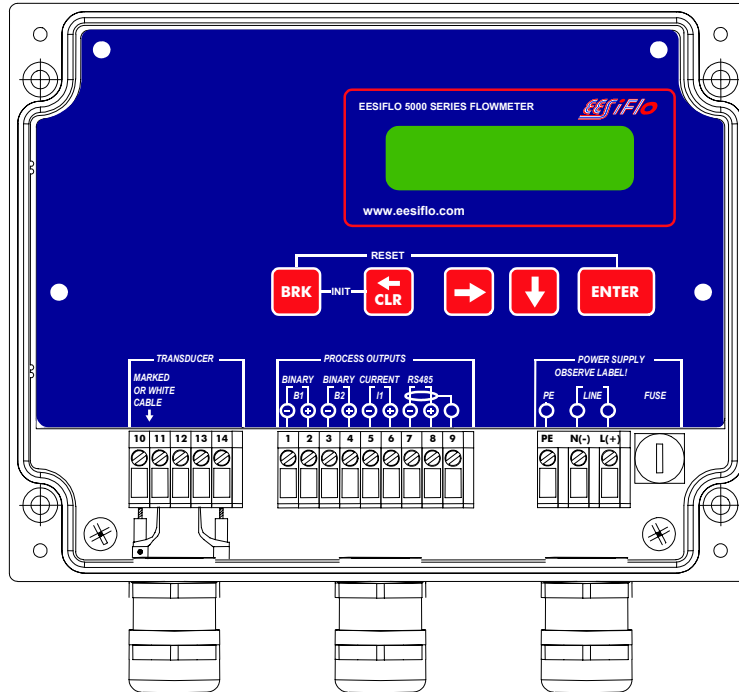

SONALOK 7S

51 / 52 Series

ULTRASONIC FLOWMETER

USER'S MANUAL

SONALOK_7S-PV1-2EN



Remarks:

IBM is a protected trademark of International Business Machines Corporation.

MS-DOS, Excel, Windows are trademarks of Microsoft Corporation.

Die Sprache, in der die Anzeigen auf dem EESIFLO erscheinen, kann eingestellt werden (siehe Abschnitt 6.3.1).

EESIFLO can be operated in the language of your choice (see section 6.3.1).

Il est possible de sélectionner la langue utilisée par EESIFLO à l'écran (voir section 6.3.1).

EESIFLO puede ser manejado en el idioma de su elección (ver sección 6.3.1).

Table of Contents

1	Introduction	7
1.1	Regarding this Manual	7
1.2	Safety Precautions	7
2	Handling	9
2.1	First Inspection	9
2.2	General Precautions	9
2.3	Service	9
2.4	Cleaning	9
3	Flowmeter	10
3.1	Measuring Principle	10
3.2	Description of the Flowmeter	11
3.3	Serial Number	12
3.4	Keyboard	13
4	Selection of the Measuring Point	14
4.1	Acoustic Penetration	14
4.2	Undisturbed Flow Profile	16
5	Installation	19
5.1	Location	19
5.2	Installation	19
5.3	Connection of the Transducers (terminal strip KL1)	20
5.4	Connection with the Power Supply (terminal strip KL3)	22
5.5	Connection of the Outputs (terminal strip KL2)	22
6	Start-up	24
6.1	Switching on	24
6.2	Displays	24
6.3	HotCodes	26
6.4	Interruption of the Power Supply	27
7	Basic Measurement	28
7.1	Input of the Pipe Parameters	28
7.2	Input of the Medium Parameters	30
7.3	Other Parameters	32
7.4	Selection of the Channels	32

7.5	Define Number of Sound Paths	33
7.6	Mounting and Positioning the Transducers	34
7.7	Start of Measurement	39
7.8	Recognition of Flow Direction	39
7.9	Stopping of Measurement.....	39
8	Displaying the Measured Values	40
8.1	Selection of the Physical Quantity and of the Unit of Measurement	40
8.2	Toggling between the Channels	41
8.3	Setting the Display	42
8.4	Status Line	42
8.5	Transducer Distance.....	43
9	Advanced Measuring Functions	44
9.1	Command Execution during Measurement	44
9.2	Damping Factor	44
9.3	Totalizers	45
9.4	Upper Limit of the Flow Velocity	46
9.5	Cut-off Flow	47
9.6	Calculation Channels.....	48
9.7	Change of Limit for the Inner Pipe Diameter	51
9.8	Program Code	51
10	Settings	53
10.1	Time and Date	53
10.2	Dialogs and Menus	53
10.3	Measurement Settings.....	55
10.4	Setting the Contrast	56
10.5	Instrument Information.....	56
11	SuperUser-Modus	57
11.1	Activating/Deactivating	57
11.2	Malfunctions in SuperUser Mode.....	57
12	Outputs	58
12.1	Installation of an Output.....	58
12.2	Error Value Delay	62
12.3	Circuits of the Outputs	63
12.4	Activation of an Analog Output	63

12.5	Activation of a Pulse Output	64
12.6	Activation of an Alarm Output	65
12.7	Behavior of the Alarm Outputs	68
12.8	Deactivating the Outputs	70
13	Troubleshooting	71
13.1	Problems with the Measurement	72
13.2	Correct Selection of the Measuring Point	73
13.3	Maximum Acoustic Contact	73
13.4	Application Specific Problems	73
13.5	High Measuring Deviations	74
13.6	Problems with the Totalizers	75
A	Technical Data	76
B	Menu Structure	81
C	Reference	89

1 Introduction

1.1 Regarding this Manual

This manual has been written for the personnel operating the ultrasonic flowmeter Sonalok 7S. It contains important information on the flowmeter, how to handle it correctly and how to avoid damages. Always keep this manual at hand.

Get acquainted with the safety rules and the handling precautions. Make sure you have read and understood this manual before using the flowmeter.

All reasonable effort has been made to ensure the correctness of the content of this manual. If you, however, find some erroneous information, please inform us. We will be grateful for any suggestions and comments regarding the concept and your experience working with the flowmeter.

This will ensure that we can further develop our products for the benefit of our customers and in the interest of technological progress. If you have any suggestions about improving the documentation and particularly this User Manual, please let us know so that we can consider your comments for future reprints.

The content of this manual is subject to changes without prior notice. All rights reserved. No part of this manual may be reproduced in any form without EESIFLO's written permission.

1.2 Safety Precautions

You will find in this manual the following safety information:

Note!	The notes contain important information which help you use the flowmeter optimally.
Attention!	This text contains important instructions which should be respected to avoid damage or destruction of the flowmeter. Proceed with attention!
	This text denotes an action which could result in injury or death of personal. Proceed with attention!

Respect these safety precautions!

1.2.1 Warranty

The Sonalok 7S flowmeter is guaranteed for the term and to the conditions specified in the sales contract provided the equipment has been used for the purpose for which it has been designed and operated according to the instructions given in this User Manual. Mis-use of the EESIFLO will immediately revoke any warranty given or implied. This includes:

- replacement of a component of Sonalok 7s by a component that was not authorized by EESIFLO
- unsuitable or insufficient maintenance
- repair of Sonalok by unauthorized personnel

EESIFLO assumes no responsibility for injury to the customer or third persons proximately caused by the material owing to defects in the product which were not predictable or for any indirect damages.

Sonalok is a very reliable instrument. It is manufactured under strict quality control, using modern production techniques. If installed as recommended in an appropriate location, used cautiously and taken care of conscientiously, no troubles should appear.

If any problem appears which can not be solved with the help of this manual (see chapter 13), contact our sales office giving a precise description of the problem. Specify the type, serial number and firmware version of the flowmeter.

2 Handling

2.1 First Inspection

The flowmeter has already been tested thoroughly at the factory. At delivery, proceed to a visual control to make sure that no damage has occurred during transportation.

Check that the specifications of the flowmeter delivered correspond to the specifications given on the purchase order.

Type and serial number of the flowmeter are given on the data plate on the Sonalok. The transducer type is printed on the transducers.

2.2 General Precautions

Sonalok is a precision measuring instrument and must be handled with care. To obtain good measurement results and not to damage the flowmeter, it is important to pay great attention to the instructions given in this user manual, and particularly to the following points:

- Protect the flowmeter from excessive shock.
- Do not open the housing without authorization.
- Keep the transducers clean. Manipulate the transducer cables cautiously. Avoid excessive cable bend.
- Make sure to work under correct ambient and operating conditions (see annex A Technical Data).
- Take the degree of protection into account (see annex A Technical Data).

2.3 Service

No service work is necessary. Always respect the handling precautions and the instructions given in this manual.

If Sonalok is installed correctly, in an appropriate location and as recommended, used cautiously and taken care of conscientiously, no troubles should appear.

Attention! Never replace a component of the instrument by parts other than those supplied by EESIFLO!
--

2.4 Cleaning

- Clean the instrument with a soft cloth. Do not use detergents.
- Remove traces of acoustic coupling compound from the transducers with a soft paper tissue.

3 Flowmeter

3.1 Measuring Principle

Sonalok uses ultrasonic signals for the flow measurement of a medium, employing the so-called transit time method. Ultrasonic signals are emitted by a first transducer installed on one side of a pipe, reflected on the opposite side and received by a second transducer. These signals are emitted alternatively in flow direction and against it.

Because the medium in which the signals propagate is flowing, the transit time of the sound signals propagating in the direction of flow is shorter than the transit time of the signal propagating against the direction of flow.

The transit-time difference Δt is measured and allows the determination of the average flow velocity on the propagation path of the ultrasonic signals. A flow profile correction is then performed in order to obtain the area average of the flow velocity, which is proportional to the volume flow.

Sonalok tests with its special electronics the incoming ultrasonic signals for their usefulness for the measurement and evaluates the plausibility of the measured values. The integrated microprocessor controls the complete measuring cycle, eliminating disturbance signals by statistical signal processing techniques.

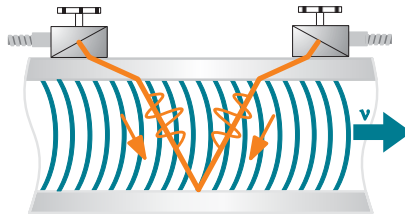

Fig. 3.1: Path of the ultrasonic signal

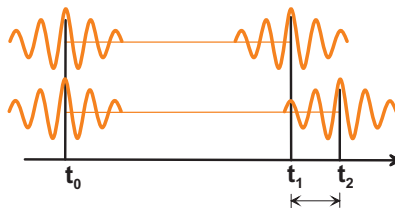

Fig. 3.2: Transit time difference Δt

3.2 Description of the Flowmeter

EESIFLO SONALOK 51 Series has 1 measuring channel.
 EESIFLO SONALOK 52 Series has 2 measuring channels.

3.2.1 Design

The front plate has to be removed to access the command panel.

Attention! The degree of protection of the flowmeter is only guaranteed if the cable glands are tightly screwed and the front plate is tightly screwed with the housing.

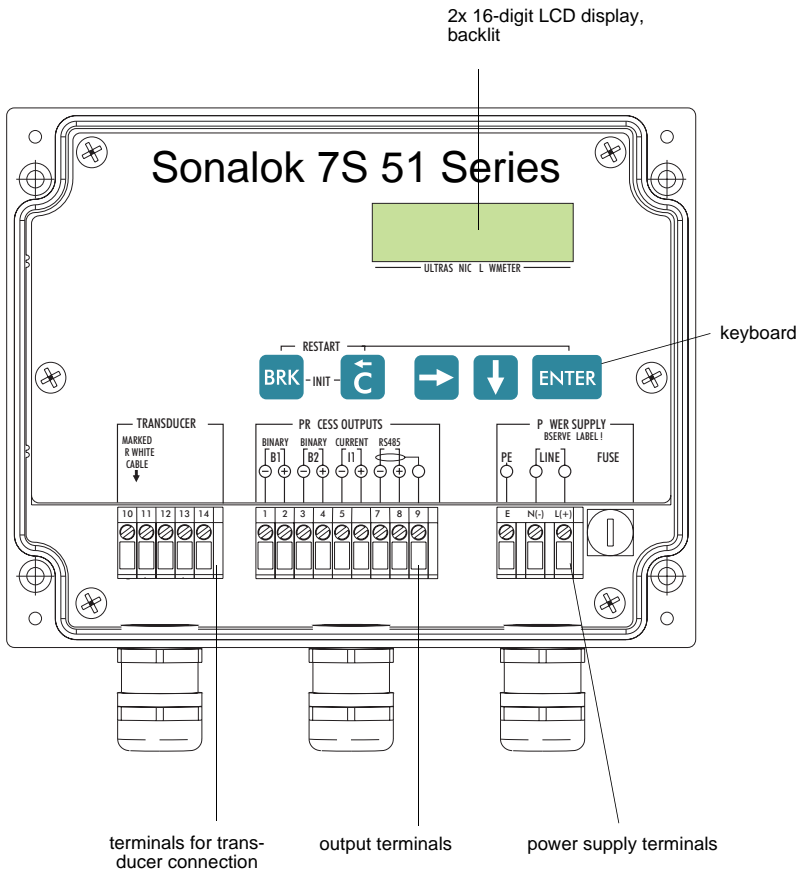

Fig. 3.3: Command panel of Sonalok 7S 51 Series

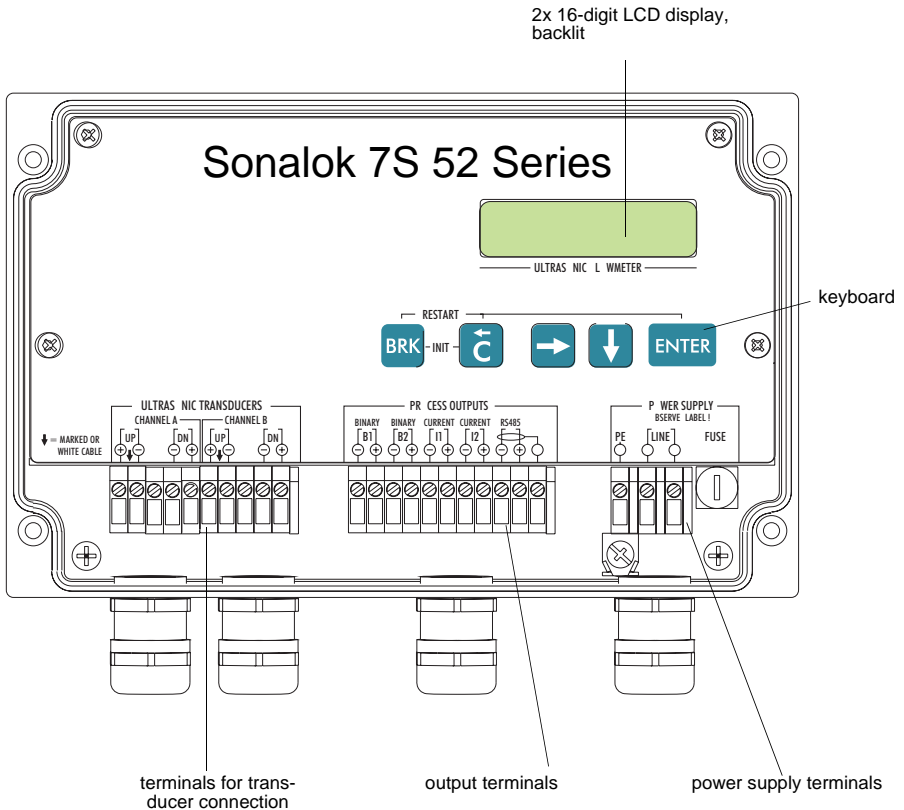

Fig. 3.4: Command panel of Sonalok 7S 52 Series

3.3 Serial Number

Type and serial number are on the data plate on the side of the flowmeter. When contacting EESIFLO, always have both numbers and the number of the firmware version at hand (see section 10.5).

3.4 Keyboard

The keyboard consists of five keys.

Table 3.1: General functions

ENTER	confirm the selection or the entered value
BRK + C + ENTER	RESET: Press these three keys simultaneously to recover from an error. The reset has the same effect as restarting the flowmeter. Stored data will not be affected.
BRK	interruption of the measurement and selection of the main menu Note: Be careful not to interrupt a current measurement by inadvertently pressing key BRK!

Table 3.2: Navigation



	scroll to the right or upwards through a scroll list
	scroll to the left or downwards through a scroll list

Table 3.3: Input of numbers



	move cursor to the right
	scroll through the digits above cursor
C	move cursor to the left. When the cursor is on the left margin: <ul style="list-style-type: none"> • an already edited value will be reset to the previously saved value • an unedited value will be deleted. If the entered value is not valid, an error message will be displayed. Press ENTER and enter a correct value.

Table 3.4: Input of text



	move cursor to the right
	scroll through character set above cursor
C	reset all characters to last saved entry

Table 3.5: Cold start

BRK + C	<p>INIT (cold start): Most parameters and settings are reset to the factory default values. The memory will not be deleted.</p> <p>Keep the two keys pressed while switching on the flowmeter until the main menu is displayed.</p> <p>A cold start during operation is executed as follows:</p> <ul style="list-style-type: none"> • Press the keys BRK, C and ENTER simultaneously. • Release only key ENTER. A RESET is executed. • Keep the keys BRK and C pressed until the main menu is displayed.
---------	---

4 Selection of the Measuring Point

The correct selection of the measuring point is crucial for achieving reliable measurement results and a high accuracy. A measurement must take place on a pipe

- where the sound can propagate (see section 4.1) and
- with a fully developed rotationally symmetrical flow profile (see section 4.2).

The correct transducer positioning is an essential condition for error-free measurement. It guarantees that the sound signal will be received under optimum conditions and evaluated correctly.

Because of the variety of applications and the different factors influencing the measurement, there can be no standard solution for the transducer positioning. The correct position of the transducers will be influenced by the following factors:

- diameter, material, lining, wall thickness and form of the pipe
- medium
- presence of gas bubbles in the medium.

Note! Avoid measuring points in the vicinity of deformations and defects of the pipe and in the vicinity of weldings.

Avoid locations where deposits are building in the pipe. Make sure that the ambient temperature at the selected location is within the operating temperature range of the transducers (see annex A Technical Data).

4.1 Acoustic Penetration

It must be possible to penetrate the pipe with acoustic signals at the measuring point. The acoustic penetration is reached when pipe and medium do not attenuate the sound signal so strongly that it is completely absorbed before reaching the second transducer. The attenuation of pipe and medium depends on:

- kinematic viscosity of the medium
- proportion of gas bubbles and solids in the medium
- deposits on the inner pipe wall
- pipe material.

The following conditions have to be respected at the measuring point:

- the pipe is always filled completely
- no solid deposits are building
- no bubbles accumulate.

Note! Even bubble-free media can form gas pockets when the medium expands, e.g. before pumps and after great cross-section extensions.

Observe the notes in Table 4.1.

Table 4.1: Measuring points to be avoided

Free supply or return pipe section:

Select the measuring point at a pipe location where the pipe can not run empty.

correct

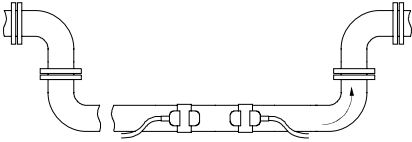

disadvantageous

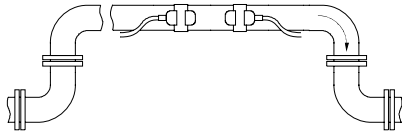

correct

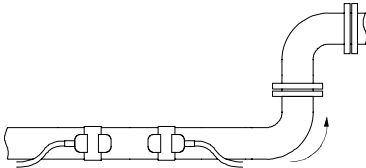

disadvantageous

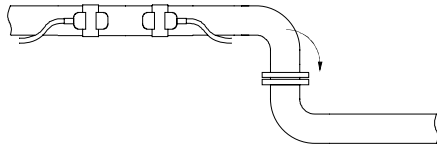

Vertical pipe

Select the measuring point at a pipe location where the medium flows upward. The pipe must be completely filled.

correct

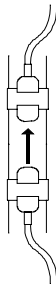

disadvantageous

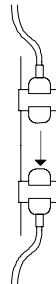
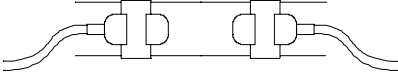
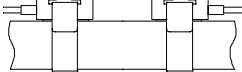

Table 4.1: Measuring points to be avoided

Horizontal pipe	
Select a measuring point where the transducers can be mounted on the side of the pipe, so that the sound waves propagate horizontally in the pipe. Thus, solids deposited on the bottom of the pipe and the gas pockets developing at the top will not influence the propagation of the signal.	
correct	disadvantageous
	

4.2 Undisturbed Flow Profile

Many flow elements (elbows, slide valves, valves, control valves, pumps, reducers, diffusers, etc.) cause a distortion of the flow profile. The axisymmetrical flow profile needed for correct measurement is no longer given. A careful selection of the measuring point helps to reduce the impact of disturbance sources.

It is most important that the measuring point is chosen at a sufficient distance from any disturbance source. Only then it can be assumed that the flow profile in the pipe is fully developed. However, Sonalok will give you significant measuring results even under non-ideal measuring conditions if:

- e.g. a medium contains a certain proportion of gas bubbles or solids or
- the recommended distances to disturbance sources can not be observed for practical reasons.

Recommended straight inlet and outlet pipe lengths are given for different types of flow disturbance sources in the examples in Table 4.2.

Table 4.2: Recommended distance from disturbance sources

(D = nominal pipe diameter at the measuring point, L = recommended distance)

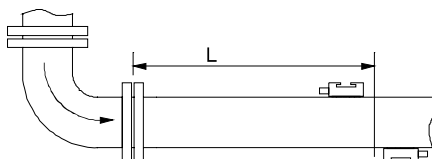
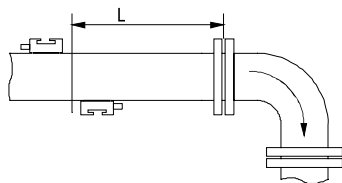
disturbance source: 90° elbow	
supply: $L \geq 10D$	return: $L \geq 5D$
	

disturbance source: 2x 90 ° elbows in one plane

supply: $L \geq 25D$

return: $L \geq 5D$

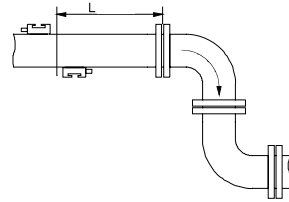
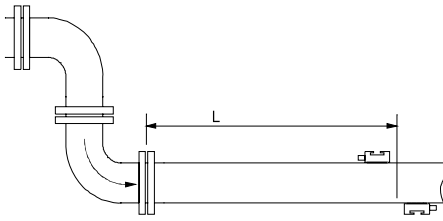

disturbance source: 2x 90 ° elbows in different planes

supply: $L \geq 40D$

return: $L \geq 5D$

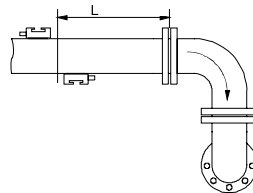
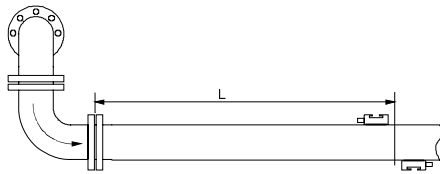

disturbance source: T piece

supply: $L \geq 50D$

return: $L \geq 10D$

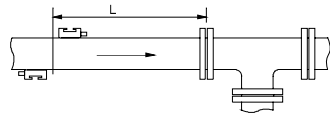

disturbance source: diffuser

supply: $L \geq 30D$

return: $L \geq 5D$

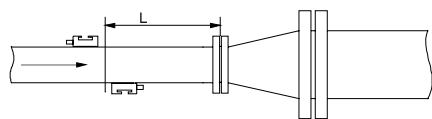
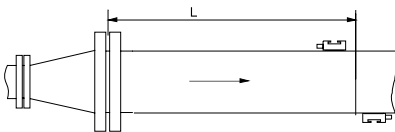

disturbance source: reducer
supply: $L \geq 10D$

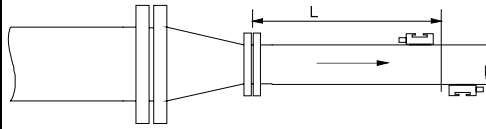

return: $L \geq 5D$

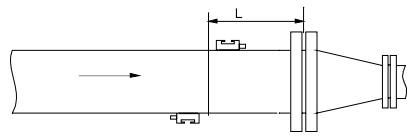

disturbance source: valve
supply: $L \geq 40D$

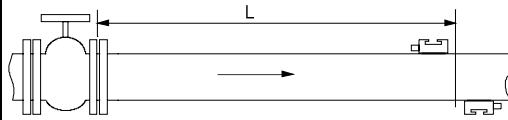

return: $L \geq 10D$

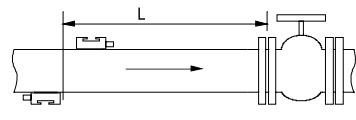

disturbance source: pump
supply: $L \geq 50D$

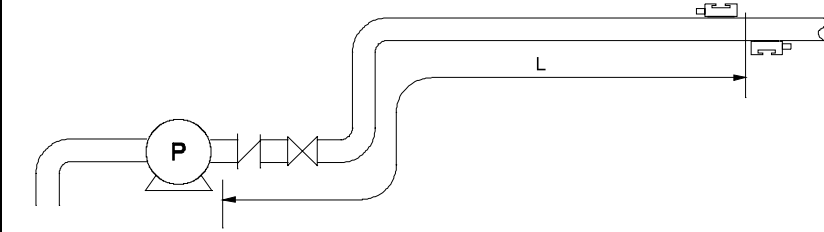

5 Installation

5.1 Location

Select the measuring point according to the recommendations in chapter 4 and make sure that the ambient temperature is within the operating temperature range of the transducers (see annex A Technical Data).

Select the location of the flowmeter within cable reach of the measuring point. Make sure that the ambient temperature is within the operating temperature range of the flowmeter (see annex A Technical Data).

5.2 Installation

- Remove the front plate from the housing of the flowmeter.
- Drill four holes in the wall at the selected location (see Fig. 5.1 or Fig. 5.2).
- Insert dowels in the holes and fix the housing with screws in the wall.

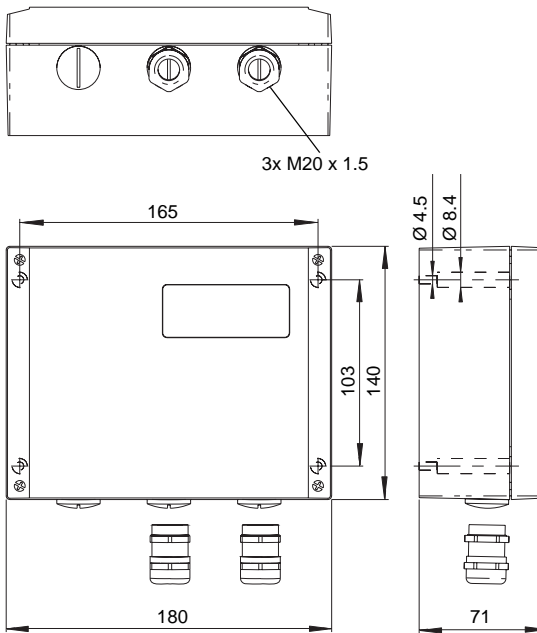

Fig. 5.1: Dimensions of Sonalok 7S 51 Series (in mm)

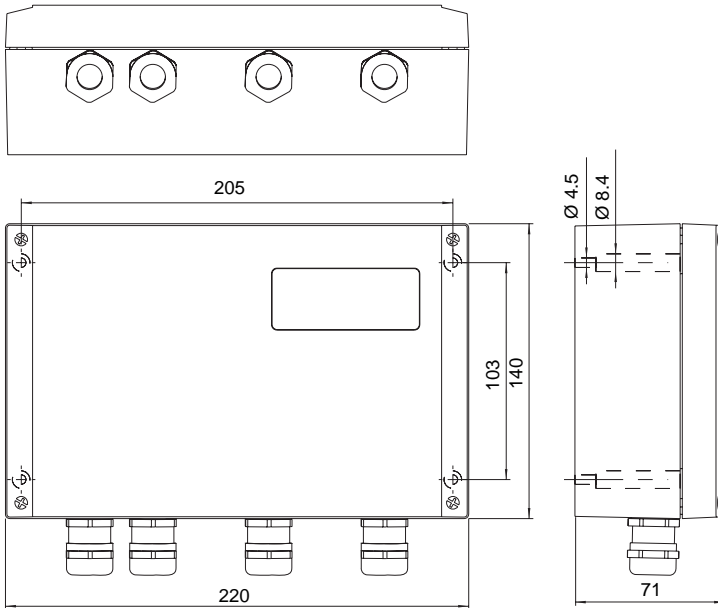

Fig. 5.2: Dimensions of Sonalok 7S 52 Series (in mm)

5.3 Connection of the Transducers (terminal strip KL1)

Note!

It is recommended to run the cables from the measuring point to the flowmeter before the connection of the transducers to avoid load on the connectors.

Note!

The degree of protection of the flowmeter is only guaranteed if the cable glands are tightly screwed and the front plate is tightly screwed with the housing.

Connecting the Transducer Cable to the Flowmeter

- Prepare the connection cable as shown in Fig. 5.4.
- Remove the outer left blind plug from the housing (see Fig. 3.3 or Fig. 3.4).
- Open the cable gland (see Fig. 5.3). The compression part (2) remains in the cap nut (1).

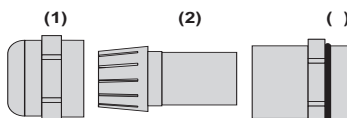

Fig. 5.3: Cable gland: cap nut (1), compression part (2), basic part (3)

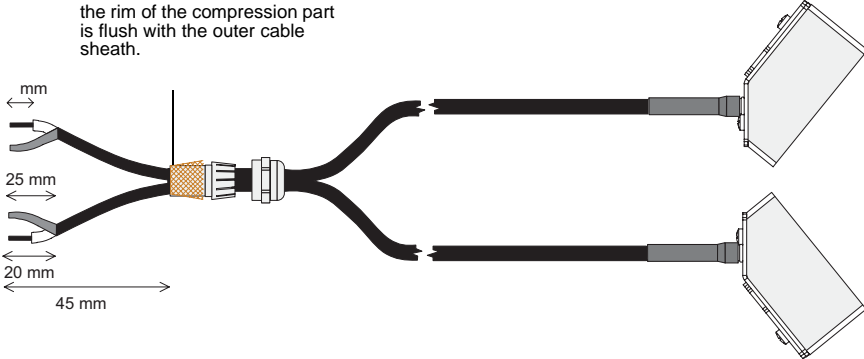

Fig. 5.4: Connection of the transducers to the flowmeter

- Press the cap nut (1) with the compression part (2) on the cable until the thin rim of the compression part is flush with the outer cable sheath (see Fig. 5.4 and Fig. 5.3).
- Cut the outer shield of the transducer cable and brush it back.

Note! For good high frequency shielding it is important to assure good contact between the cable shield and the cap nut (and thus the housing).

- Screw the basic part (3) with the housing.
- Insert the end of the transducer cable with the uninsulated leads in the housing.
- Fix the cable gland by screwing the cap nut (1) on the basic part (3).
- Connect the leads to the terminals of the flowmeter (see Fig. 5.5 or Fig. 5.6).

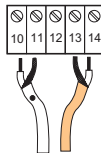

Fig. 5.5: Connection of the transducer cable with Sonalok 7S 51 Series

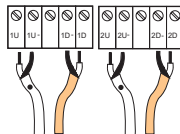

Fig. 5.6: Connection of the transducer cable with Sonalok 7S 52 Series

5.4 Connection with the Power Supply (terminal strip KL3)



Install an external safety switch so that the power supply of the flowmeter can be interrupted rapidly at any time. The switch must be located near the flowmeter. Use a switch with appropriate disconnection effect.

- Prepare the power cable with a M20 cable gland.
- Remove the outer right blind plug from the housing (see Fig. 3.3 or Fig. 3.4).
- Screw the gasket ring side of the basic part (3 in Fig. 5.3) in the housing.
- Push the cable through the basic part (3) in the housing.
- Fix the cable gland by screwing the cap nut (1) on the basic part (3).
- Connect the leads to the terminals of the flowmeter (see Table 5.1).

Table 5.1: Connection with the power supply

Terminal	connection AC	connection DC
PE	earth	earth
N(-)	neutral	- DC
L(+)	Phase 100...230 V AC, 50/60 Hz	+ DC

5.5 Connection of the Outputs (terminal strip KL2)

- Prepare the output cable with a M20 cable gland.
- Remove the second filler plug on the right from the housing (see Fig. 3.3 or Fig. 3.4).
- Screw the gasket ring side of the basic part (3 in Fig. 5.3) in the housing.
- Push the cable through the basic part (3) in the housing.
- Fix the cable gland by screwing the cap nut (1) on the basic part (3).
- Connect the leads to the terminals of the flowmeter (see Table 5.2 or Table 5.3).

Attention!

The degree of protection of the flowmeter is only guaranteed if the cable glands are tightly screwed and the front plate is tightly screwed with the housing.

Table 5.2: Connection of the outputs of Sonalok 7S 51 Series

terminal	connection
1, 2	binary output B1
3, 4	binary output B2
5, 6	current output I1
7	-
8	-
9	-

Table 5.3: Connection of the outputs of Sonalok 7S 52 Series

terminal	connection
1, 2	binary output B1
3, 4	binary output B2
5, 6	current output I1
7, 8	current output I2
9	-
10	-
11	-

Table 5.4: Default settings of the outputs of Sonalok 7S 51 Series

output	current output I1
source channel	A
source item	measured value
measured value	physical quantity
output range	4...20 mA
error output	3.5 mA

Table 5.5: Default settings of the outputs of Sonalok 7S 52 Series

output	current output I1	current output I2
source channel	A	B
source item	measured value	measured value
measured value	physical quantity	physical quantity
output range	4...20 mA	4...20 mA
error output	3.5 mA	3.5 mA

These settings can be changed. For installation of the outputs see section 12.1. For the activation of the outputs see section 12.4...12.6.

6 Start-up

6.1 Switching on

```
EESIFLO
5X00-25X00100
```

As soon as the power supply is connected to the flowmeter, the serial number of the flowmeter is displayed for a short time.

Data can not be entered while the serial number is displayed.

```
>PAR< mea opt sf
Parameter
```

After initialization, the main menu is displayed in the selected language. The language of the display can be set (see section 6.3.1).

6.2 Displays



6.2.1 Main Menu

```
>PAR< mea opt sf
Parameter
```

The main menu contains the program branches:

- PAR (Parameter)
- MEA (Measuring)
- OPT (output options)
- SF (special functions)

The selected program branch is displayed in capital letters between arrows. The full name of the selected program branch is displayed in the lower line.

Use key  and  to select a program branch. Press ENTER.

Note!	By pressing key BRK, the measurement will be stopped and the main menu selected.
--------------	--

Note!	In this manual, all program entries and keys are indicated in capital letters. Program entries are indicated in typewriter characters (PARAMETER). The menu items will be separated from the main menu by a backslash "\".
--------------	---

6.2.2 The Program Branches and their Menu Items

- The pipe and medium parameters will be input in the program branch `PARAMETER`.
- The steps for the measurement will be processed in the program branch `MEASURING`.
- Physical quantity with unit of measurement and all parameters necessary for the measured value output will be defined in the program branch `OUTPUT OPTIONS`.
- All functions that are not directly related with the measurement are in the program branch `SPECIAL FUNCTION`.

For an overview of the program branches see section 6.2.3. For a detailed overview of the menu structure see annex B.

6.2.3 Overview of the Program Branches

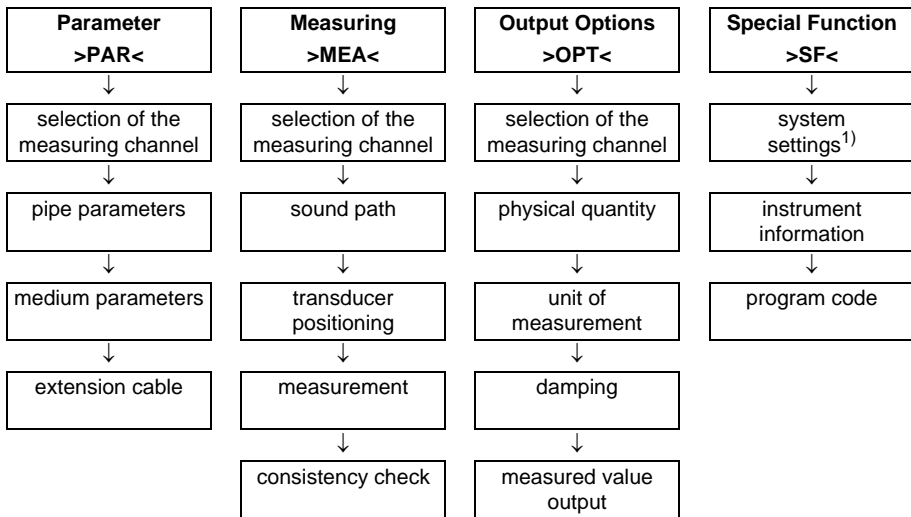

¹ The following menu items are in `SYSTEM SETTINGS`:

- dialogs/menus
- measurement
- outputs
- Miscellaneous
- set clock

6.2.4 Navigation

If a vertical arrow \updownarrow is displayed, the menu item contains a scroll list. The current list item is displayed in the lower line.

```
Parameter       $\updownarrow$ 
for Channel    A:
```

Scroll with key \downarrow and \rightarrow to select a list item in the lower line. Press ENTER.

In some menu items, there is a horizontal scroll list in the lower line. The selected list item is displayed between arrows.

```
Lining
no                >YES<
```

Scroll with key \downarrow and \rightarrow to select a list item in the lower line. Press ENTER.

In some menu items, there is a horizontal scroll list in the upper line. The selected list item is displayed in capital letters between arrows. The current value of the list item is displayed in the lower line.

```
R1=FUNC<typ mode
Function:      MAX
```

Scroll with key \rightarrow to select a list item in the upper line.

Scroll with key \downarrow to select a value for the selected list item in the lower line.

Press ENTER.

6.3 HotCodes

A HotCode is a key sequence activating some settings:

- language selection (see section 6.3.1)
- switching on the SuperUser mode (see chapter 11)
- manual input of the lower limit for the inner pipe diameter (see section 9.7)

```
SYSTEM settings  $\updownarrow$ 
Miscellaneous
```

Select SPECIAL FUNCTION\SYSTEM SETTINGS\MISCELLANEOUS.

```
Input a HOTCODE
no                >YES<
```

Select YES to enter a HotCode.

```
Please input a
HOTCODE: 000000
```

Enter the HotCode. Press ENTER.

```
INVALID HOTCODE
HOTCODE: 000000
```

An error message will be displayed if a HotCode not valid is entered. Press ENTER.

```
Input a HOTCODE
no                >YES<
```

Select YES to enter the HotCode again or NO to return the menu item MISCELLANEOUS.

6.3.1 Language Selection

Sonalok can be operated in the languages listed below. The language can be selected with the following HotCodes:

Table 6.1: Language HotCodes

909031	Dutch
909033	French
909034	Spanish
909044	English
909049	German

Depending on the technical data of the flowmeter, some of the languages might not be implemented.

When the last digit is entered, the main menu will be displayed in the selected language. The selected language remains activated after switching the flowmeter off and on again. The language can be selected as often as required.

Note!

After initializing of the flowmeter (keys BRK and C during switching on), the display will be indicated in the factory preset language.

6.4 Interruption of the Power Supply

All current measuring parameters will be stored in a non-volatile cold start resistant EPROM as soon as the measurement begins. The operation of the flowmeter will be interrupted if the power supply fails. All input data are preserved.

EESIFLO 5X00-25X00100

After return of the power supply, the serial number will be displayed for a few seconds.

The interrupted measurement will be continued. All selected output options are still active.

The flowmeter does not continue the measurement after return of the power supply if a cold start was performed.

7 Basic Measurement

The pipe and medium parameters will be entered for the selected measuring point (see chapter 4). The ranges are limited by the characteristics of the transducers and of the flowmeter. An error message will be displayed if the limits are exceeded (MINIMUM and MAXIMUM plausibility check).

7.1 Input of the Pipe Parameters

```
Outer Diameter
1100.0      MAXIMAL
```

The entered outer diameter in the example is too high.

The upper limit of this parameter is displayed.

example: 1100.0 mm for the connected transducers and for a pipe wall thickness of 50 mm.

Note! The parameters will be stored only if the program branch PARAMETER is finished completely once.

```
>PAR< mea opt sf
Parameter
```

Select the program branch PARAMETER. Press ENTER.

```
Parameter      ↕
for Channel    A:
```

Select the channel for which parameters are to be entered. Press ENTER.

This display will not be indicated, if the flowmeter has only one measuring channel.

7.1.1 Outer Pipe Diameter/Pipe Circumference

```
Outer Diameter
  100.0      mm
```

Enter the outer pipe diameter. Press ENTER.

Note! If the entered outer diameter is > 4000 mm, only a measurement in diagonal mode will be possible (see section 7.5).

It is possible to enter the pipe circumference instead of the outer pipe diameter (see section 10.2.1). The setting is cold start resistant. It will be activated in the program branch SPECIAL FUNCTION.

If the input of the pipe circumference has been activated and 0 (zero) is entered for the OUTER DIAMETER, the menu item PIPE CIRCUMFER. will be displayed automatically. If the pipe circumference is not to be entered, press key BRK to return to the main menu and start the parameter input again.

7.1.2 Pipe Wall Thickness

Wall Thickness	
3.0	mm

Enter the pipe wall thickness. The range depends on the connected transducers. Default is 3.0 mm. Press ENTER.

Note!

The inner diameter (= outer diameter - 2x pipe wall thickness) will be calculated internally. If the value is not within the inner pipe diameter range of the connected transducers, an error message will be displayed.

It is possible to change the lower limit of the inner pipe diameter for a given transducer type (see section 9.7).

7.1.3 Pipe Material

The pipe material has to be selected to determine the sound velocity. The sound velocities for the materials in the scroll list are stored in the flowmeter.

Pipe Material	↕
Carbon Steel	

Select the pipe material from the scroll list.

If the material is not in the scroll list, select OTHER MATERIAL. Press ENTER.

When the pipe material is selected, the corresponding sound velocity is set automatically. If OTHER MATERIAL is selected, the sound velocity has to be entered.

c-Material	
3230.0	m/s

Enter the sound velocity of the pipe material.

Values between 600.0 m/s and 6553.5 m/s will be accepted. Press ENTER.

Note!

Enter the sound velocity of the material (i.e. longitudinal or transversal velocity) which is nearer to 2500 m/s.

For the sound velocity of some materials see annex C, Table C.1.

7.1.4 Pipe Lining

Lining	
no	>YES<

If the pipe has an inner lining, select YES. Press ENTER.

If NO is selected, the next parameter will be displayed (see section 7.1.5).

lining	↕
Bitumen	

Select the medium from the scroll list.

If the material is not in the scroll list, select OTHER MATERIAL. Press ENTER.

If **OTHER MATERIAL** is selected, the sound velocity has to be entered.

c-Material	
3200.0	m/s

Enter the sound velocity of the lining material. Values between 600.0 m/s und 6553.5 m/s will be accepted.

Press ENTER.

For the sound velocity of some materials see annex C, Table C.1.

Liner Thickness	
3.0	mm

Enter the thickness of the liner. Default is 3.0 mm.

Press ENTER.

Note!

The inner diameter (= outer diameter - 2x pipe wall thickness - 2x liner thickness) will be calculated internally. If the value is not within the inner pipe diameter range of the connected transducers, an error message will be displayed.

7.1.5 Pipe Roughness

The flow profile of the medium is influenced by the roughness of the inner pipe wall. The roughness will be used for the calculation of the profile correction factors. As the pipe roughness can not be exactly determined in most cases, it has to be estimated.

For the roughness of some materials see annex C, Table C.2. The values are based on experience and measurements.

Roughness	
0.4	mm

Enter the **ROUGHNESS** for the selected pipe or lining material.

Values between 0.0 mm and 5.0 mm will be accepted. Default for steel as pipe material is 0.1 mm.

Change the value according to the condition of the inner pipe wall. Press ENTER.

7.2 Input of the Medium Parameters

Medium	⇕
Water	

Select the medium from the scroll list.

If the medium is not in the scroll list, select **OTHER MATERIAL**. Press ENTER.

If a medium is selected from the scroll list, the menu item for the input of the medium temperature will be displayed directly (see section 7.2.4).

If **OTHER MEDIUM** is selected, the medium parameters have to be entered first (see the following sections):

- min. and max. sound velocity
- kinematic viscosity
- density

7.2.1 Sound Velocity

The sound velocity of the medium is used for the calculation of the transducer distance at the beginning of the measurement. However, the sound velocity does not influence the measuring result directly. Often, the exact value of the sound velocity for a given medium is unknown. A range of possible values for the sound velocity must therefore be entered. These displays are indicated only if `OTHER MEDIUM` has been selected.

c-Medium	MIN
1400.0	m/s

Enter the min. and max. sound velocity of the medium. Values between 500.0 m/s and 3500.0 m/s will be accepted. Press ENTER after each input.

7.2.2 Kinematic Viscosity

The kinematic viscosity influences the flow profile of the medium. The entered value and other parameters will be used for the profile correction. This display is indicated only if `OTHER MEDIUM` has been selected.

Kinem. Viscosity	
1.00	mm ² /s

Enter the kinematic viscosity of the medium. Values between 0.01 mm²/s and 30 000.00 mm²/s will be accepted. Press ENTER.

7.2.3 Density

The density of the medium has to be entered. The mass flow will be calculated on the basis of the density (product of volume flow and density). This display is indicated only if `OTHER MEDIUM` has been selected.

Note!	If the mass flow is not measured, press ENTER. The other measuring results will not be influenced.
--------------	--

Density	
1.00	g/cm ³

Enter the operating density of the medium.

Values between 0.01 g/cm³ and 20.00 g/cm³ will be accepted.

7.2.4 Medium Temperature

The medium temperature is used for the interpolation of the sound velocity and for the calculation of the recommended transducer distance at the beginning of the measurement.

During measurement, the medium temperature will be used for the interpolation of density and viscosity of the medium.

Medium Temperat.	
20.0	°C

Enter the medium temperature. The value must be within the operating temperature range of the transducers. Default is 20 °C. Press ENTER.

7.3 Other Parameters

7.3.1 Cable Length

```
Additional cable
  65.0          m
```

If the transducer cable has to be extended, enter the additional cable length (e.g. between the junction box and the flowmeter). Press ENTER.

7.4 Selection of the Channels

The channels on which will be measured can be activated individually. This is only possible if the flowmeter has more than one measuring channel.

```
par >MEA< opt sf
Measuring
```

Select the program branch MEASURING. Press ENTER.

```
par >MEA< opt sf
NO DATA      !
```

If this error message is displayed, the parameters are not complete. Enter the missing parameters in the program branch PARAMETER.

```
KANAL: >A< B Y Z
MESSEN  ✓  ✓  -  .
```

The channels for the measurement can be activated and deactivated.



This display will not be indicated, if the flowmeter has only one measuring channel.

The symbols mean:

- ✓: the channel is active
- : the channel is not active
- : the channel can not be activated

Note!

A measuring channel can not be activated if the parameters are not valid, e.g. if the parameters in the program branch PARAMETER of the channel are not complete.

- Select a channel with key .
- Press key  to activate or deactivate the selected channel.
- Press ENTER.

A deactivated channel will be ignored during the measurement. Its parameters will remain unchanged.

7.5 Define Number of Sound Paths

The sound path is the number of the transits of the ultrasonic waves through the medium in the pipe.

At an odd number of transits (diagonal mode), the transducers will be mounted on opposite sides of the pipe.

At an even number of transits (reflection mode), the transducers will be mounted on the same sides of the pipe.

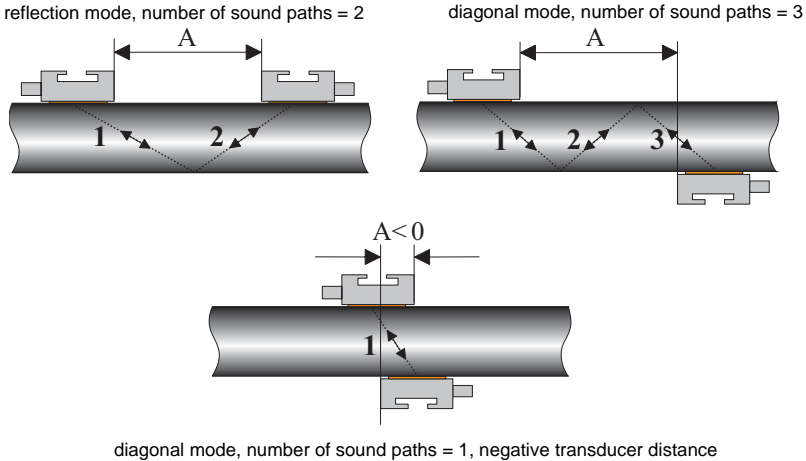

Fig. 7.1: Sound path and transducer distance (A)

An increased number of transits means increased accuracy of the measurement. However, the increased transit distance leads to a higher attenuation of the signal. The reflections on the opposite pipe wall and deposits on the inner pipe wall cause additional amplitude losses of the sound signal.

If the signal is attenuated strongly by the medium, the pipe, deposits, etc., the number of sound paths has to be set to 1 if necessary.

Note! Correct positioning of the transducer is easier for an even number of transit paths than for an odd number.

A: Sound Path
4 NUM

A value for the number of sound paths corresponding to the connected transducers and the entered parameters will be recommended. Change the value if necessary. Press ENTER.

7.6 Mounting and Positioning the Transducers

7.6.1 Transducer Distance

```
Transd. Distance
A:54 mm Reflec
```

A value for the transducer distance will be recommended. Mount the transducers on the pipe adjusting this value (see section 7.6.2). Press ENTER.

A - measuring channel
 REFLEC - reflection mode
 DIAGON - diagonal mode

The transducer distance given here is the distance between the inner edges of the transducers. A negative transducer distance is possible for a measurement in diagonal mode on very small pipes (see Fig. 7.1).

Note! The accuracy of the recommended transducer distance depends on the accuracy of the pipe and medium parameters entered.

7.6.2 Mounting the Transducers

The transducer will be mounted that the engravings on the transducers form an arrow (see Fig. 7.2). The arrow does not need to show in flow direction (see section 7.8). The transducer cables show then in opposite directions.

Note! The engravings should also form an arrow if the transducers are mounted on opposite sides of the pipe.

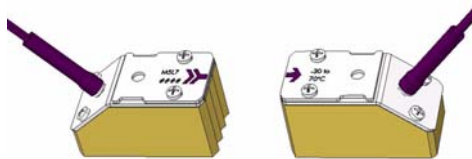

Fig. 7.2: Correct positioning of the transducers (A = transducer distance)

The transducers will be fixed to the pipe by means of the supplied transducer mounting fixture.

Rust, paint or other deposits on the pipe will absorb the sound signal. To reach a maximum acoustic contact between pipe and transducers, the measuring point as to be prepared as follows:

- Clean the pipe at the transducer positions.
- Remove rust or loose paint.
- An existing paint layer on the pipe should be sanded for a better measuring result.
- Use coupling foil or apply a bead of acoustic coupling compound along the center line onto the contact surface of the transducer. Do not spread the acoustic coupling compound on the contact surface, but press the transducer on the pipe at the measuring point.
- There should be no air pockets between transducer contact surface and pipe wall. Make sure that the transducer mounting fixture applies the necessary pressure on the transducers.

7.6.3 Mounting the Transducers with Transducer Shoes and Tension

Straps *(Mounting fixtures will be subjected to change with/without any prior notices.)*

- Cut the tension straps (pipe circumference + 120 mm).
- Make sure that part (2) of the clasp is on top of part (1) (see Fig. Fig. 7.3). The hooks of part (2) must be on the outer side of the clasp.
- Pull approx. 2 cm of the tension strap through the slot of the clasp (see Fig. 7.4) to fasten the strap to the clasp.
- Bend the strap end back to fasten the strap to the clasp. Guide the free end of the tension strap through the groove on the top of the transducer shoe.
- Place the clasp on the side of the pipe just in front of you. Lay the tension strap around the pipe (see Fig. 7.5).
- Place the transducer shoe on the pipe. Hold clasp and transducer shoe with one hand while pushing the tension strap through parts (2) and (1) of the clasp (see Fig. 7.3).
- Pull the tension strap firmly and engage it in the inner hooks of the clasp.

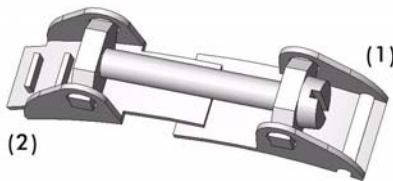

Fig. 7.3: Clasp

Note!

At pipes with large diameters, use tongs, if necessary, to tense the tension strap.

Note! The clasp must be completely in contact with the pipe to ensure a good fixation.



Fig. 7.4: Clasp with tension strap

- Mount the second transducer shoe in the same way adjusting the displayed transducer distance by means of the measuring tape.
- Tighten the screws of the clasps.
- Push the transducers in the transducer shoes. Press the transducer firmly on the pipe. There should be no air pockets between transducer surface and pipe wall. Tighten the screw of the transducer shoe firmly.

Note! When the transducers are mounted on a vertical pipe and Sonalok is placed lower than the pipe, the cable of the upper transducer should be fixed by a cable tie to the tension strap to protect the cable from mechanical strain.

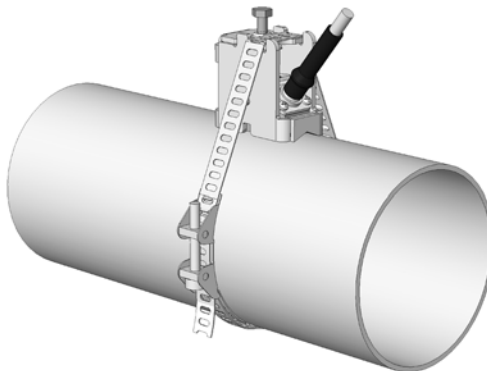
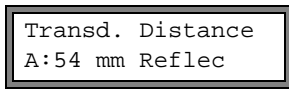

Fig. 7.5: Mounted transducer in transducer shoe

7.6.4 Fine Adjustment of the Transducer Distance



If the displayed transducer distance is adjusted, press ENTER.

The positioning procedure is started.

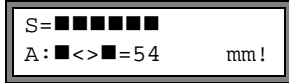

A bar graph S= displays the amplitude of the received signal.

Shift the transducer slightly in the range of the recommended transducer distance until the bar graph has max. length (max. 6 squares)

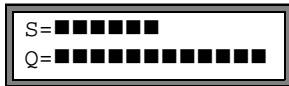

By scrolling with key through the upper line and with key through the lower line

- transducer distance
- bar graph Q= (signal quality), must have max. length
- transit time TRANS. in microseconds
- bar graph S= (signal amplitude) can be displayed.

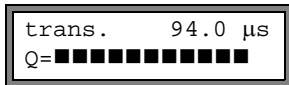

If the signal is not sufficient for measurement, Q= UNDEF will be displayed.

In case of larger deviations, check if the entered parameters are correct or repeat the measurement at a different location on the pipe.

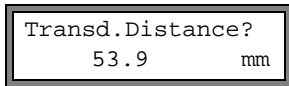

After the precise positioning of the transducers, the recommended transducer distance is displayed again.

Enter the actual (precise) transducer distance. Press ENTER.

Repeat the steps for all channels on which will be measured. The measurement will be started automatically afterwards.

7.6.5 Consistency Check

If a wide range for the sound speed has been entered in the program branch PARAMETER or the exact parameters of the medium are not known, a consistency check is recommended.

The transducer distance can be displayed during measurement by scrolling with key .

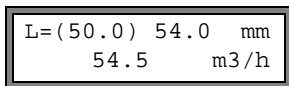

In the upper line, the optimum transducer distance is displayed in parentheses (here: 50.0 mm), followed by the entered transducer distance (here: 54.0 mm). The latter value must correspond to the actually adjusted transducer distance. Press ENTER to optimize the transducer distance.

The optimum transducer distance is calculated on the basis of the measured sound speed. It is therefore a better approximation than the first value which had been calculated on the basis of the approximate sound speed range entered in the program branch PARAMETER.

If the difference between optimum and entered transducer distance is less than given in Table 7.1, the measurement is consistent and the measured values are valid. The measurement can be continued.

If the difference is greater, adjust the transducer distance to the displayed optimum value. Afterwards, check the signal quality and the signal amplitude bar graph (see section 7.6.4). Press ENTER.

Table 7.1: Standard values for signal optimization during consistency check

transducer type	difference between optimum and actual transducer distance
Q	< 6 mm
M	< 10 mm

Transd.Distance? 50.0 mm

Enter the new adjusted transducer distance. Press ENTER.

L=(51.1) 50.0 mm 54.5 m3/h

Scroll with key  again until the transducer distance is displayed and check the difference between optimum and adjusted transducer distance. Repeat the steps if necessary.

Note! Never change the transducer distance during measurement without having restarted the consistency check!
--

Repeat the steps for all channels on which will be measured.

7.6.6 Value of the Sound Speed

The sound velocity of the medium can be displayed during measurement by pressing key .

If an approximate range for the sound speed has been entered in the program branch PARAMETER and the transducer distance has been optimized afterwards as described in section 7.6.5, it is recommended to note the sound velocity for the next measurement. The optimization procedure does not need to be repeated then.

Also take note of the temperature of the medium as the sound speed depends on the temperature. The value can be entered in the program branch PARAMETER.

7.7 Start of Measurement

A:Volume Flow
31.82 m ³ /h

The measured values will be displayed in the lower line. Press ENTER to return to the fine adjustment of the transducer distance (see section 7.6.4).

If more than one measuring channel is available/activated, the flowmeter works with an integrated measuring point multiplexer providing quasi simultaneous measurement on the different measuring channels. The flow is measured on one channel for approx. 1 second, then the multiplexer switches to the next activated channel. The measuring time depends on the measuring conditions. If, e.g. the measuring signal can not be detected immediately, the measurement might take longer than 1 second.

The results are displayed according to the actually selected output options (see chapter 8). The default unit of measurement for the volume flow is m³/h. The selection of the values to be displayed and the setting of the output options are described in chapter 8. Advanced measuring functions are described in chapter 9.

7.8 Recognition of Flow Direction

The flow direction in the pipe can be recognized with the help of the displayed volume flow in conjunction with the arrow engraved on the transducers:

- The medium flows in arrow direction if the displayed volume flow is positive (e.g. 54.5 m³/h).
- The medium flows against the arrow direction if the displayed volume flow is negative (e.g. -54.5 m³/h).

7.9 Stopping of Measurement

The measurement can be interrupted at any time by pressing key BRK if not being protected by a program code (see section 9.8).

Note!	Be careful not to interrupt a current measurement by inadvertently pressing key BRK!
--------------	--

8 Displaying the Measured Values

The physical quantity will be set in the program branch `OUTPUT OPTIONS` (see section 8.1). The designation of the physical quantity will be displayed normally in the upper line, its value in the lower line. The display can be adapted (see section 8.3).

8.1 Selection of the Physical Quantity and of the Unit of Measurement

Depending on the configuration of the flowmeter, the following physical quantities can be measured:

- **flow velocity:** is calculated on the basis of the measured transit time difference
- **operational volume flow:** will be calculated by multiplying the flow velocity by the cross-section of the pipe
- **mass flow:** will be calculated by multiplying the operational volume flow by the operational density of the medium

The physical quantity will be selected as follows:

```
par mea >OPT< sf
Output Options
```

Select the program branch `OUTPUT OPTIONS`. Press `ENTER`.

```
Output Options ⬆
for Channel A:
```

Select the channel for which the output options are to be set. Press `ENTER`.

This display will not be indicated, if the flowmeter has only one measuring channel.

```
Physic. Quant. ⬆
Volume Flow
```

Select the physical quantity in the scroll list. Press `ENTER`.

```
Volume in ⬆
m3/h
```

For the selected physical quantity, a scroll list with the available units of measurement is displayed. The previously selected unit of measurement is displayed first.

Select the unit of measurement for the selected physical quantity. Press `ENTER`.

Return to the main menu by pressing key `BRK`. The further menu items of the program branch `OUTPUT OPTIONS` are for the activation of the measured value output.

Note!

If the physical quantity or the unit of measurement is changed, the settings of the outputs have to be checked (see chapter 12).

8.2 Toggling between the Channels

If more than one channel is available/activated, the display for the measured values can be adapted as follows:

- AutoMux mode
 - all channels
 - only calculation channels
- HumanMux mode

With the command `→MUX:AUTO/HUMAN` will be toggled between the modes (see section 9.1).

8.2.1 AutoMux Mode

In AutoMux mode, the display and the measuring process are synchronized. The channel on which is currently measured will be displayed at the left side of the upper line (A:, B:, etc.).

The measured values will be displayed as configured in the program branch `OUTPUT OPTIONS` (see section 8.1). When the multiplexer switches to the next channel, the display is actualized.

A:Volume Flow 54.5 m ³ /h
--

B:Flow Velocity 1.25 m/s

The AutoMux mode is the default display mode. It will be activated automatically after a cold start.

All Channels

The measured values of all channels (measuring and calculation channels) will be displayed. The next activated measuring channel will be switched to after min. 1.5 seconds.

Only Calculation Channels

The measured values of the calculation channels will be displayed only. The next active calculation channel will be switched to after min. 1.5 seconds.

Note!	This mode can only be activated if min. two calculation channels are activated.
--------------	---

8.2.2 HumanMux Mode

The measured values of one channel will be displayed in HumanMux mode. The measurement on the other channels will be continued, but not displayed:

```
B:Flow Velocity
   1.25      m/s
```

The selected channel will be displayed at the left side of the upper line.

Select the command `→MUX:NEXTCHAN.` to display the next activated channel. The measured values of the selected channel will be displayed as configured in the program branch `OUTPUT OPTIONS` (see section 8.1).

8.3 Setting the Display



During measurement, the display can be set as to display two measured values simultaneously (one in each line of the display). This does not have influence on the totalizing, the measured value output, etc.

The following information can be displayed in the upper line:

- designation of the physical quantity
- totalizer values, if activated
- measuring mode
- transducer distance
- alarm state indication, if activated (see section 12.7.5) and if alarm outputs are activated

The following information can be displayed in the lower line:

- flow velocity
- sound velocity
- mass flow
- volume flow

The display in the upper line can be changed during measurement with key . The display in the lower line can be changed during measurement with key .

```
A:Flow Velocity
*   2.47      m/s
```

The character * indicates that the displayed value (here: flow velocity) is not the selected physical quantity.

8.4 Status Line

Important data of the current measurement are summarized in the status line. Quality and precision of the current measurement can be estimated.

```
A: S8 Q5 c✓ RT F↓
```

The status line will be selected by scrolling during measurement with key  through the upper line.

	value	explanation
S	0	signal amplitude: < 5 %

	9	≥ 90 %
Q	0	signal quality: < 5 %

	9	≥ 90 %
c		sound velocity: comparison of the measured and expected sound velocity of the medium. The expected sound velocity is calculated on the basis of the medium parameters (medium selected in the program branch PARAMETER, temperature dependency).
	√	ok, corresponds to the expected value
	↑	> 20 % of the expected value
	↓	< 20 % of the expected value
	?	unknown, can not be measured
R		flow profile: information about the flow profile based on the Reynold's number
	T	fully turbulent flow profile
	L	fully laminar flow profile
	↕	the flow is in the transition range between laminar and turbulent flow
	?	unknown, can not be calculated
F		flow velocity: comparison of the measured flow velocity with the flow limits of the system
	√	ok, flow velocity is not in a critical range
	↑	the flow velocity is higher than the actual limit
	↓	the flow velocity is lower than the actual cut-off flow (even if it is not set to zero)
	0	the flow velocity is in the offset range of the measuring method
	?	unknown, can not be measured

8.5 Transducer Distance

$L = (51.1) \ 50.0 \text{ mm}$ $54.5 \quad \text{m3/h}$
--

By pressing key  it is possible during measurement to scroll to the display of the transducer distance.

The current optimum transducer distance is displayed in parentheses (here: 51.2 mm), followed by the entered transducer distance (here: 50.8 mm).

The optimum transducer distance might change during measurement (e.g. due to temperature fluctuations).

A possible deviation from the optimum transducer distance (here: -0.4 mm) will be compensated internally.

Attention!	Never change the transducer distance during measurement!
-------------------	--

9 Advanced Measuring Functions

9.1 Command Execution during Measurement

Commands executable during a measurement are shown in the upper line. A command always begins with →. If programmed, a program code has to be entered (see section 9.8.1).

Scroll in the upper line with key  until the needed command is displayed. Press ENTER. The following commands are available:

Table 9.1: Commands that can be executed during measurement

COMMAND	explanation
→ADJUST SENSORS	 <p>Select transducer positioning. If a program code is active, the current measurement will be automatically continued 8 seconds after the last keyboard entry.</p>
→CLEAR TOTALIZER	 <p>The totalizers will be reset to zero.</p>
→MUX:AUTO/HUMAN	<p>Toggle between AutoMux and HumanMux mode (see section 8.2).</p> <p>This display will not be indicated, if the flowmeter has only one measuring channel or only one measuring channel is active.</p>
→MUX:NEXTCHAN.	<p>displays the next channel</p> <p>This display will not be indicated, if the flowmeter has only one measuring channel or only one measuring channel is active.</p>
→BREAK MEASURE	<p>Stop measuring and return to main menu.</p>

9.2 Damping Factor

Each displayed measured value is the floating average of all measured values of the last x seconds, where x is the damping factor. A damping factor of 1 s means that the measured values are not averaged as the measuring rate is approx 1/s. The default value of 10 s is appropriate for normal flow conditions.

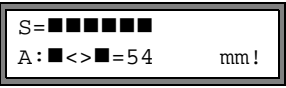
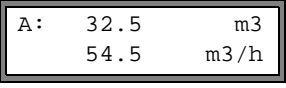
Strongly fluctuating values caused by high flow dynamics require a larger damping factor.

Select the program branch `OUTPUT OPTIONS`. Press ENTER until the menu item `DAMPING` is displayed.

```
Damping
  10      s
```

Enter the damping factor. Values between 1 s and 100 s will be accepted. Press ENTER.

Press key BRK to return to the main menu.

9.3 Totalizers

Total volume or mass of the medium at the measuring point can be determined.

There are two totalizers, one for the positive flow direction, one for the negative flow direction.

The unit of measurement used for totalization corresponds to the volume or mass unit selected for the physical quantity.

The value of a totalizer consists of max. 11 digits, including max. 3 decimal places.

```
A:Volume Flow
  54.5    m3/h
```

Scroll in the upper line with key  to display the totalizers.

```
A:   32.5    m3
     54.5    m3/h
```

The value of the totalizer will be displayed in the upper line (here: the volume which has passed through the pipe at the measuring point in positive flow direction since the activation of the totalizers).

- Press ENTER while a totalizer is displayed to toggle between the display of the totalizers for both flow directions.
- Select the command \rightarrow CLEAR TOTALIZER in the upper line to reset the totalizers to zero. Press ENTER.

```
A:NO COUNTING !
  3.5      m/s
```

This error message is indicated if the totalizers are to be activated on a measuring channel where the flow velocity is measured. The flow velocity can not be totalized.

9.3.1 Store the Totalizer Values

When the Measurement is Interrupted

The behavior of the totalizers after an interruption of the measurement or after a RESET of the flowmeter will be set in SPECIAL FUNCTION\SYSTEM SETTINGS\MEASURING\QUANTITY RECALL. The setting is cold start resistant.

```
Quantity recall
off          >ON<
```

If ON is selected, the values of the totalizers will be stored and used for the next measurement.

If OFF is selected, the totalizers will be reset to zero.

9.3.2 Overflow of the Totalizers

The overflow behavior of the totalizers can be set:

Without overflow: The value of the totalizer increases to the internal limit of 10^{38} .

The values will be displayed as exponential numbers ($\pm 1.00000E10$), if necessary. The totalizer can only be reset to zero manually.

With overflow: The totalizer will be reset to zero automatically as soon as ± 9999999999 is reached.

Select in `SPECIAL FUNCTION\SYSTEM SETTINGS\MEASURING` the menu item `QUANT. WRAPPING`. The setting is cold start resistant.

```
Quant. wrapping
off                >ON<
```

Select `ON` to work with overflow. Select `OFF` to work without overflow.

Independently of the selected list item, the totalizers can be reset manually to zero.

Note!

The output of the sum of both totalizers (the throughput ΣQ) via an output will not be valid anymore after the first overflow (wrapping) of one of the respective totalizers.

To signalize the overflow of a totalizer, an alarm output with the switching condition `QUANTITY` and the type `HOLD` has to be activated.

9.4 Upper Limit of the Flow Velocity

Single outliers caused by heavily disturbed surroundings can appear in the measured values of the flow velocity. If outliers are not ignored, they will affect all derived physical quantities, which will then be unsuitable for integration (e.g. pulse outputs).

It is possible to ignore all measured flow velocities higher than a preset upper limit. These measured values will be marked as outliers.

The upper limit of the flow velocity will be set in `SPECIAL FUNCTION\SYSTEM SETTINGS\MEASURING`. The setting is cold start resistant.

```
Velocity limit
0.0          m/s
```

Select the menu item `VELOCITY LIMIT`.

Enter 0 (zero) to switch off the detection of outliers.

Enter a limit > 0 to switch on the detection of outliers. The measured flow velocity will be compared then to the entered upper limit.

Values between 0.1 m/s and 25.5 m/s will be accepted.

Press `ENTER`.

If the flow velocity is higher than the upper limit,

- the flow velocity will be marked as invalid. The physical quantity can not be determined.
- "!" will be displayed after the unit of measurement. (In case of a normal error, "?" will be displayed.)

Attention! If the upper limit is too low, a measurement might be impossible, as most of the measured values will be marked "invalid".

9.5 Cut-off Flow

The cut-off flow function automatically sets all measured flow velocities to zero that are below a preset value. All values derived from this measured value will be also set to zero.

The cut-off flow can depend on the flow direction or not. The default is 2.5 cm/s (0.025 m/s). The max. value is 12.7 cm/s (0.127 m/s). The cut-off value will be set in `SPECIAL FUNCTION\SYSTEM SETTINGS\MEASURING`. The setting is cold start resistant.

```
Cut-off Flow
absolut    >SIGN<
```

Select `SIGN` to define a cut-off flow dependent on the flow direction. There are two independent limits to be set for the positive and negative flow directions.

Select `ABSOLUTE` to define a cut-off flow independent of the flow direction. There is only one limit to be set.

The absolute value of the measured value will be compared to the cut-off flow.

```
Cut-off Flow
factory    >USER<
```

Select `FACTORY` to use the default value of 2.5 cm/s (0.025 m/s) for the cut-off flow.

Select `USER` to enter the cut-off flow.

Press `ENTER`.

If `CUT-OFF FLOW\SIGN` and `USER` are selected, two values have to be entered:

```
+Cut-off Flow
  2.5      cm/s
```

Enter the cut-off flow for positive measured values. All positive values of the flow velocity less than this limit will be set to zero.

```
-Cut-off Flow
 -2.5      cm/s
```

Enter the cut-off flow for negative measured values. All negative values of the flow velocity greater than this limit will be set to zero.

If `CUT-OFF FLOW\ABSOLUT` and `USER` is selected, only one value has to be entered:

```
Cut-off Flow
  2.5      cm/s
```

The limit will be compared to the absolute value of the measured flow velocity.

9.6 Calculation Channels

Note! Calculation channels are only available if the flowmeter has more than one measuring channel.

In addition to the ultrasonic measuring channels, Sonalok has two virtual calculation channels Y and Z. The measured values of the measuring channels A and B will be summed up by the calculation channels.

The result of the calculation is the measured value of the selected calculation channel. This measured value is equivalent to the measured values of a measuring channel. All operations with the measured values of a measuring channel (totalizing, online output, outputs, etc.) can be done with the values of a calculation channel, too.

9.6.1 Characteristics of the Calculation Channels

- In the program branch `PARAMETER`, the measuring channels to be used for the calculation and the calculation function have to be entered.
- A calculation channel can not be attenuated. The damping factor has to be set separately for each of the two measuring channels.
- Two cut-off flows for each calculation channel can be defined. The cut-off flow is not based on the flow velocity as for measuring channels. Instead it will be defined in the unit of measurement of the physical quantity selected for the calculation channel. During measurement, the calculated values are compared to the cut-off flow values and set to zero if necessary.
- A calculation channel provides a valid measured value if both measuring channels provide valid measured values.

9.6.2 Parameterization of a Calculation Channel

Parameter ⇕
for Channel Y:

Select a calculation channel (Y or Z) in the program branch `PARAMETER`. Press `ENTER`.

Calculation:
Y= A - B

The current calculation function will be displayed. Press `ENTER` to edit the function.

```
>CH1< funct ch2 ⬆
  A      -      B
```

Three scroll lists are displayed in the upper line:

- selection of the first measuring channel (CH1)
- selection of the calculation function (FUNCT)
- selection of the second measuring channel (CH2)

Select a scroll list with key **→**.

The list items will be displayed in the lower line.

Scroll with key **↓** through the scroll list. All measuring channels and their absolute values can be used for the calculation.

```
ch1 >FUNCT< ch2 ⬆
|A| (+)/2 |B|
```

The following calculation functions are available:

- -: $Y = CH1 - CH2$
- +: $Y = CH1 + CH2$
- (+)/2: $Y = (CH1 + CH2)/2$
- |-|: $Y = |CH1 - CH2|$

Press ENTER.

9.6.3 Output Options for a Calculation Channel

```
Output Options ⬆
for Channel Y:
```

Select a calculation channel in the program branch OUTPUT OPTIONS. Press ENTER.

```
Physic. Quant. ⬆
Mass Flow
```

Select the physical quantity to be calculated. Press ENTER.

Make sure that the physical quantity selected for the calculation channel can be calculated from the physical quantities of the selected measuring channels. Table 9.2 shows the possible combinations.

Table 9.2: Physical quantity of the calculation channel

physical quantity of the calculation channel	possible physical quantity of the first measuring channel (CH1)			possible physical quantity of the second measuring channel (CH2)			
	flow velocity	volume flow	mass flow	flow velocity	volume flow	mass flow	
flow velocity	x	x	x	x	x	x	
volume flow		x	x		x	x	
mass flow		x	x		x	x	

example: The difference of the volume flows of the channels A and B has to be determined. The physical quantity of measuring channels A and B can be the volume flow or the mass flow, but not the flow velocity. The physical quantities of the measuring channels do not need to be identical (channel A = mass flow, channel B = volume flow).

```
Mass in      ↕
kg/h
```

Select the unit of measurement. Press ENTER.

Two cut-off flows for each calculation channel can be defined. They will be defined in the unit of measurement of the physical quantity selected for the calculation channel.

```
+Cut-off Flow
  1.00      kg/h
```

All positive calculated values below the limit will be set to 0.

```
-Cut-off Flow
 -2.00      kg/h
```

All negative calculated values exceeding the limit will be set to 0.

9.6.4 Measuring with Calculation Channels

```
par >MEA< opt sf
Measuring
```

Select the program branch MEASURING. Press ENTER.

```
CHANN: A B >Y< Z
MEASUR ✓ ✓ ✓ .
```

Activate the desired channels. Calculation channels will be activated or deactivated like a measuring channel. Press ENTER.

```
WARNING! CHANNEL
B: INACTIV!
```

If a measuring channel is not activated although being used for an activated calculation channel, a warning will be displayed. Press ENTER.

Position the transducers for all activated measuring channels. The measurement will be started automatically afterwards.

```
Y:Flow Velocity
  53.41      m/s
```

When a calculation channel has been activated, the HumanMux mode (see section 8.2.2) will be selected at the beginning of the measurement and the values of the calculation channel will be displayed.

If the AutoMux mode is selected, the measured values of the measuring channels, but not of the calculation channels will be displayed alternately.

```
Y: A - B
  53.41      m/s
```

Press key  to display the calculation function.

Press key  to display the measured values of the various channels.

9.7 Change of Limit for the Inner Pipe Diameter

It is possible to modify the lower limit of the inner pipe diameter for a certain transducer type. The setting is cold start resistant.

Enter HotCode 071001 (see section 6.3).

DNmin Q-Sensor
15 mm

Enter the lower limit of the inner pipe diameter for the displayed transducer type. Press ENTER to select the next transducer type.

Values between 3 mm and 63 mm will be accepted.

Attention!	If a transducer is used below its recommended inner pipe diameter, a measurement might be impossible.
-------------------	---

9.8 Program Code

A current measurement can be protected from an inadvertent intervention by a program code.

If a program code was defined, it will be requested as soon as there is an intervention in the measurement (a command or key BRK).

If a program code is active, the message PROGRAM CODE ACTIVE will be displayed when a key is pressed.

To start a command, it is sufficient to enter the first three digits of the program code (= access code).

To interrupt a current measurement, the complete program code has to be entered (= break code).

The input of a program code will be interrupted by key C.

Attention!	Do not forget the program code!
-------------------	---------------------------------

Special Funct. ⬆
Set program code

Select in the program branch SPECIAL FUNCTION the menu item PROGRAM CODE.

Program Code

Enter a program code with max. 6 digits. Press ENTER.

INVALID CODE!
909049

An error message will be displayed if a reserved number has been entered (e.g. a HotCode for language selection).



A program code remains valid as long as:

- no other valid program code is entered or
- the program code is not deactivated.

9.8.1 Intervention in the Measurement

Key BRK will be pressed:

```
INPUT BREAK_CODE
CODE:      000000
```

Enter the program code with the keys  and . Press ENTER.



```
INPUT BREAK_CODE
INVALID CODE
```

If the entered program code is not valid, an error message will be displayed for a few seconds.

If the entered program code is valid, the measurement will be interrupted.

A command will be selected:

```
INP. ACCESS_CODE
CODE:      000000
```

Enter the first three digits of the program code with the keys  and . Press ENTER.

At first 000000 will be displayed. If the program code starts with 000, ENTER can be pressed directly.

9.8.2 Deactivation of the Program Code

```
Program Code
-----
```

Select in the program branch SPECIAL FUNCTION the menu item PROGRAM CODE.

The program code will be deleted by entering -----. Press ENTER.

If the character “-” is entered less than six times, this character string will be used as new program code.

10 Settings

10.1 Time and Date

EESIFLO has a battery buffered clock.

10.1.1 Time

```
SYSTEM settings ⬆
Set Clock
```

Select in SPECIAL FUNCTION\SYSTEM SETTINGS the list item SET CLOCK. Press ENTER.

```
TIME          11:00
ok            >NEW<
```

The actual time is displayed. Select OK to confirm the time or NEW to set the time. Press ENTER.

```
TIME          11:00
Set Time      !
```

Select the digit to be edited by key .

Edit the selected digit by key  and C.

Press ENTER.

```
TIME          11:11
>OK<         new
```

The new time will be displayed. Select OK to confirm the time or NEW to set the time again. Press ENTER.

10.1.2 Date

After the time has been set, DATE will be displayed.

```
DATE  25.01.2007
ok            >NEW<
```

Select OK to confirm the date or NEW to set the date. Press ENTER.

```
DATE  25.01.2007
Set Date  !
```

Select the digit to be edited by key .

Edit the selected digit by key  and C.

Press ENTER.

```
DATE  26.01.2007
>OK<         new
```

The new date will be displayed. Select OK to confirm the date or NEW to set the date again. Press ENTER.

10.2 Dialogs and Menus

```
SYSTEM settings ⬆
Dialogs/Menu
```

Select SPECIAL FUNCTION\SYSTEM SETTINGS. Select the list item DIALOGS/MENUS. Press ENTER.

Note!

The settings of the menu item DIALOGS/MENUS will be stored at the end of the dialog. If the menu item is left before the end of the dialog, the settings will not be effective.

10.2.1 Pipe Circumference

```
Pipe Circumfer.
off          >ON<
```

Select ON if the pipe circumference has to be entered instead of the pipe diameter in the program branch `PARAMETER`. The setting is cold start resistant. Press ENTER.

```
Outer Diameter
100.0        mm
```

If ON has been selected for `PIPE CIRCUMFER.` the outer pipe diameter will be requested in the program branch `PARAMETER` nevertheless.

To change to the menu item `PIPE CIRCUMFER.`, enter 0 (zero). Press ENTER.

```
Pipe Circumfer.
314.2        mm
```

The value displayed in `PIPE CIRCUMFER.` is calculated on the basis of the last displayed value of the outer pipe diameter.

example: $100 \text{ mm} * \pi = 314.2 \text{ mm}$

```
Pipe Circumfer.
180          mm
```

Enter the pipe circumference. The parameter limits for the circumference are calculated on the basis of the limits for the outer pipe diameter.

```
Outer Diameter
57.3         mm
```

During the next scroll through the program branch `PARAMETER`, the outer pipe diameter corresponding to the entered pipe circumference will be displayed.

example: $180 \text{ mm} : \pi = 57.3 \text{ mm}$

Note! The circumference is edited temporarily only. When the flowmeter switches back to the display of the pipe circumference (internal recalculation), slight rounding errors may occur.

example: entered circumference: 100 mm
displayed outer pipe diameter: 31.8 mm

When the flowmeter switches back to the circumference internally, 99.9 mm will be displayed.

10.2.2 Transducer Distance

```
Transd. Distance
auto          >USER<
```

recommended setting: `USER`

- `USER` will be selected if the measuring point is always the same.
- `AUTO` can be selected if the measuring point changes often.

```
Transd. Distance?
(50.8) 50.0 mm
```

If the recommended and the entered transducer distance are not identical, the recommended value will be displayed in parentheses, followed by the entered transducer distance in the program branch `MEASURING`.

```
Transd. Distance?
50.8           mm
```

During transducer positioning in the program branch MEASURING

- only the entered transducer distance will be displayed if `TRANSD. DISTANCE\USER` is selected and the recommended and the entered transducer distances are identical
- only the recommended transducer distance will be displayed if `TRANSD. DISTANCE\AUTO` is selected.

10.2.3 Error Value Delay

The error value delay is the time after which an error value will be sent to an output if no valid measured values are available.

```
Error-val. delay
damping      >EDIT<
```

Select `EDIT` to enter an error value delay. Select `DAMPING` if the damping value is to be used as error value delay.

For further information on the behavior of missing measured values see sections 12.1.2 and 12.2.

10.2.4 Alarm State Indication

```
SHOW RELAIS STAT
off           >ON<
```

Select `ON` to display the alarm state during measurement.

For further information on alarm outputs see section 12.6.

Note! All changes will be stored now at the end of the configuration dialog.

10.3 Measurement Settings

```
SYSTEM settings ⇅
Measuring
```

Select in `SPECIAL FUNCTION\SYSTEM SETTINGS` the list item `MEASURING`. Press `ENTER`.

Note! The settings of the menu item `MEASURING` will be stored at the end of the dialog. If the menu item is left before the end of the dialog, the settings will not be effective.

```
Cut-off Flow
absolut      >SIGN<
```

A lower limit for the flow velocity can be entered (see section 9.5).

```
Cut-off Flow
factory      >USER<
```

```
Velocity limit
  24.0      m/s
```

An upper limit for the flow velocity can be entered (see section 9.4).

Values between 0.1 m/s and 25.5 m/s will be accepted. Enter 0 (zero) to switch off the flow velocity check.

```
Quant. wrapping
off          >ON<
```

Select the overflow behavior of the totalizers (see section 9.3.2).

```
Quantity recall
off          >ON<
```

Select ON to keep the previous totalizer values after restart of the measurement.

Select OFF to reset to zero the totalizers after restart of the measurement.

Note! All changes will be stored now at the end of the dialog.

10.4 Setting the Contrast

The contrast of the display of the flowmeter can be set in SPECIAL FUNCTION\SYSTEM SETTINGS\MISCELLANEOUS.

```
SYSTEM settings ⬆
Miscellaneous
```

Select SPECIAL FUNCTION\SYSTEM SETTINGS\MISCELLANEOUS. Press ENTER.

```
SETUP DISPLAY
←  CONTRAST  →
```

The contrast of the display will be set by the following keys:

 increases the contrast

 decreases the contrast

Note! The display will be reset to medium contrast after a cold start.

10.5 Instrument Information

```
Special Funct. ⬆
Instrum. Inform.
```

Select SPECIAL FUNCTION\INSTRUM. INFORM. to obtain information about the flowmeter. Press ENTER.

```
5X00-25X00100
V x.xx dd.mm.yy
```

Type and serial number of the flowmeter will be displayed in the upper line.

The firmware version with date is displayed in the lower line

Press ENTER.

11 SuperUser-Mode

The SuperUser mode allows experimental work. Features of the SuperUser mode are:

- Defaults will not be observed.
- There are no plausibility checks when parameters are being entered.
- There is no check whether the entered parameters are within the limit determined by physical laws and technical data.
- The cut-off flow is not active.
- A value for the number of sound paths has to entered.

It is possible to modify the lower limit of the inner pipe diameter for a certain transducer type without activating the SuperUser mode.

11.1 Activating/Deactivating

Enter HotCode 071049 to activate the SuperUser mode.



```
SUPERUSER MODE
*IS ACTIVE NOW*
```

It is displayed that the SuperUser mode is activated. Press ENTER. The main menu will be displayed.

Enter HotCode 071049 again to deactivate the SuperUser mode.

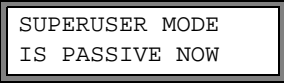

```
SUPERUSER MODE
IS PASSIVE NOW
```

It is displayed that the SuperUser mode is deactivated. Press ENTER. The main menu will be displayed.

The SuperUser mode will be deactivated by switching off the flowmeter, too.

11.2 Malfunctions in SuperUser Mode

As the SuperUser mode operates without any plausibility check, absurd entries may result in an automatic switching-off of the flowmeter or in a crash of the internal software. An absurd entry is e.g. 0 (zero) for the number of sound paths or 0.1 mm for the outer pipe diameter.

Switch on the flowmeter again and reactivate the SuperUser mode. If necessary, RESET the flowmeter by pressing keys BRK, C and ENTER simultaneously.

12 Outputs

If the flowmeter is equipped with outputs, they have to be installed and activated before they can be used:

- assigning a measuring channel (source channel) to the output (if the flowmeter has more than one measuring channel)
- defining the physical quantity (source item) to be transmitted to the output by the source channel and the properties of the signal
- defining the behavior of the output in case no valid measured values are available
- activation of the installed output in the program branch `OUTPUT OPTIONS`

12.1 Installation of an Output

The outputs will be installed in the program branch `SPECIAL FUNCTION\SYSTEM SETTINGS\PROC. OUTPUTS`.

Note! The configuration of an output will be stored at the end of the dialog. If the dialog is left by pressing key `BRK`, the changes will not be stored.

SYSTEM-settings ⬆
Proc. outputs

Select in `SPECIAL FUNCTION\SYSTEM SETTINGS` the list item `PROC. OUTPUTS`. Press `ENTER`.

Install Output ⬆
Current I1

Select the output to be installed. The scroll list contains all actually available outputs.

A tick ✓ after a list item indicates that this output has already been installed. Press `ENTER`.

I1 enable
no >YES<

This display is indicated if the output has not been installed yet. Select `YES`. Press `ENTER`.

I1 disable
>NO< yes

If the output is already installed, select `NO` to reconfigure it or `YES` to deinstall the output and to return to the previous menu item to select another output. Press `ENTER`.

I1 Source chan. ⬆
Channel A:

Select in the scroll list the measuring channel to be assigned as source channel to the output. Press `ENTER`.

This display will not be indicated, if the flowmeter has only one measuring channel or only one measuring channel is active.

I1 Source item ⬆
Measuring value

Select the physical quantity (source item) to be transmitted from the source channel to the output.

If a binary output is configured, only the list items `LIMIT` and `IMPULS` will be displayed.

The source items and their scroll lists are described in Table 12.1.

Table 12.1: Configuration of the outputs

source item	list item	output
MEASURED VALUE	-	physical quantity selected in the program branch OUTPUT OPTIONS
QUANTITY	Q+	totalizer for the positive flow direction
	Q-	totalizer for the negative flow direction
	ΣQ	sum of the totalizers (positive and negative flow direction)
LIMIT	R1	limit message (alarm output R1)
	R2	limit message (alarm output R2)
	R3	limit message (alarm output R3)
IMPULS	FROM ABS(X)	pulse without sign consideration
	FROM X > 0	pulse for positive measured values
	FROM X < 0	pulse for negative measured values
MISCELLANEOUS	SOUNDSPEED FLUID	sound velocity of the medium
	SIGNAL	signal amplitude of a measuring channel

12.1.1 Output Range

I1 Output range ⬆
4/20 mA

When configuring an analog output, the output range will be defined now. Select a list item or OTHER RANGE.. to enter the output range manually.

I1 Output MIN ⬆
10.0 mA

If OTHER RANGE.. is selected, enter the values OUTPUT MIN and OUTPUT MAX. Press ENTER after each input.

I1 Output MAX ⬆
11.0 mA

I1 Output MAX ⬆
12.0 MINIMAL

This error message will be displayed if the output range is not min. 10 % of the max. output range. The next possible value will be displayed. Repeat the input.

example: $I_{MAX} - I_{MIN} \geq 2 \text{ mA}$ for a 4...20 mA current output

12.1.2 Error Output

In the further dialog, an error value can be defined which is to be output if the source item can not be measured e.g. when gas bubbles are in the medium.

Table 12.2: Error output

error value	result
MINIMUM	output of the lower limit of the output range
HOLD LAST VALUE	output of the last measured value
MAXIMUM	output of the upper limit of the output range
OTHER VALUE ...	The value has to be entered manually. It has to be within the limits of the output.

example: The volume flow has been selected as source item for a current output, the output range is 4...20 mA, the error value delay $t_d > 0$.

The volume flow can not be measured in the time interval $t_0 \dots t_1$ (see Fig. 12.1). The error value will be output.

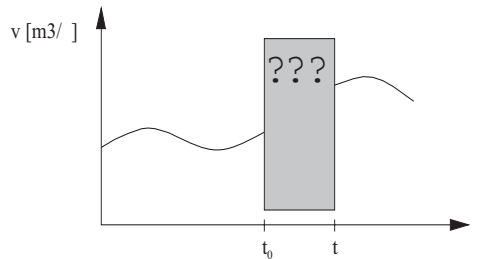
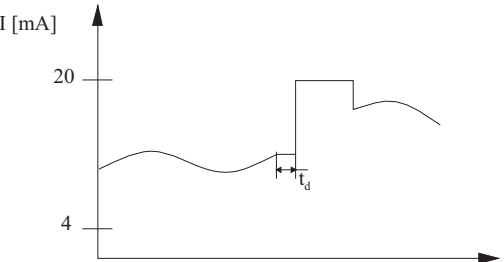
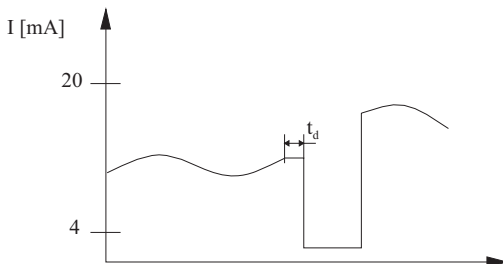

Fig. 12.1: Error output

Table 12.1: Examples for the error output

list item for the error output	output signal
<div style="border: 1px solid black; padding: 5px; width: fit-content;"> Error-value ↕ Minimum (4.0mA) </div>	
<div style="border: 1px solid black; padding: 5px; width: fit-content;"> Error-value ↕ Hold last value </div>	

Table 12.1: Examples for the error output

list item for the error output	output signal
<div style="border: 1px solid black; padding: 5px; margin-bottom: 10px;"> Error-value \updownarrow Maximum (20.0mA) </div>	
<div style="border: 1px solid black; padding: 5px; margin-bottom: 10px;"> Error-value \updownarrow Other value ... </div> error output = 2.00 mA	

Error-value \updownarrow
 Minimum (4.0mA)

Select a list item for the error output. Press ENTER.

Error-value:
 3.5 mA

If OTHER VALUE ... is selected, enter an error value. It has to be within the limits of the output.

Press ENTER.

Note! The settings will be stored now at the end of the dialog.

I1 active loop
 Klemmen:P1+,P1-

The terminals to be used are now displayed (here: P1+ und P1- for the active current loop).

Press ENTER.

12.1.3 Function Test

The function of the installed output can now be tested. Connect a multimeter to the installed output.

Test of the Analog Outputs

```
I1:Output Test
      4      mA
```

The current output is tested in the example. Enter a test value. It has to be within the output range. Press ENTER.

```
I1= 4.0 mA
Again? no >YES<
```

If the multimeter displays the entered value, the output works.

Select YES to repeat the test, NO to return to SYSTEM SETTINGS. Press ENTER.

Test of the Binary Outputs

```
B1:Output Test ↕
Reed-Relais OFF
```

Select REED-RELAIS OFF in the scroll list OUTPUT TEST to test the de-energized state of the output. Press ENTER. Measure the resistance at the output. The value has to be high ohmic.

```
B1=OFF
Again? no >YES<
```

Select YES. Press ENTER.

```
B1:Output Test ↕
Reed-Relais ON
```

Select REED-RELAIS ON in the scroll list OUTPUT TEST to test the energized state of the output. Press ENTER. Measure the resistance at the output. The value has to be low ohmic.

```
B1=ON
Again? no >YES<
```

Select YES to repeat the test, NO to return to SYSTEM SETTINGS. Press ENTER.

12.2 Error Value Delay

The error value delay is the time interval after which the error value will be transmitted to the output in case no valid measured values are available. The error value delay can be entered in the program branch OUTPUT OPTIONS if this menu item has been previously activated in the program branch SPECIAL FUNCTION. If you do not enter a value for the error delay, the damping will be used.

```
Error-val.delay
>DAMPING<      edit
```

Select in SPECIAL FUNCTION\SYSTEM SETTINGS\DI-ALOGS\MENUS the menu item ERROR-VAL. DELAY.

Select DAMPING if the damping value is to be used as error value delay. Select EDIT to activate the error value delay request.

```
Error-val. delay
      10      s
```

From now on, the error value delay can be entered in the program branch OUTPUT OPTIONS. The setting is cold start resistant.

12.3 Circuits of the Outputs

Table 12.2: Circuits of the outputs

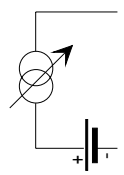
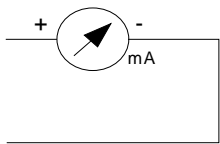
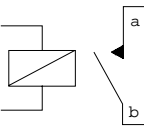
output	EESIFLO	circuits	
active current loop			$R_{LOAD} < 500 \Omega$
binary output (Reed relay)			$U_{MAX} = 24 V$ $I_{MAX} = 150 mA$

R_{LOAD} is the sum of all ohmic resistances in the circuit (resistance of the conductors, resistance of the amperemeter/voltmeter, etc.).

12.4 Activation of an Analog Output

Note!

An output can only be activated in the program branch `OUTPUT OPTIONS` if it has been previously installed.

```
Output Options  ⬆
for Channel    A:
```

Select in the program branch `OUTPUT OPTIONS` the channel for which an output has to be activated. Press `ENTER`.

This display will not be indicated, if the flowmeter has only one measuring channel.

```
Current Loop
I1: no         >YES<
```

Press `ENTER` until `CURRENT LOOP` is displayed. Select `YES` to activate the output. Press `ENTER`.

12.4.1 Measuring Range of the Analog Outputs

After an analog output has been activated in the program branch `OUTPUT OPTIONS`, the measuring range of the source item has to be entered.

```
Zero-Scale Val.
0.00          m3/h
```

Enter in `ZERO-SCALE VALUE` the lowest measured value expected. The unit of measurement of the source item will be displayed.

`ZERO-SCALE VALUE` is the measured value corresponding to the lower limit of the output range as defined in section 12.1.1.

```
Full-Scale Val.
  300.00      m3/h
```

Enter in `FULL-SCALE VALUE` the highest measured value expected.

`FULL-SCALE VALUE` is the measured value corresponding to the upper limit of the output range as defined in section 12.1.1.

example: The output range 4...20 mA was selected for a current loop, the zero-scale value was set to 0 m³/h and the full-scale value to 300 m³/h.

If the volume flow is 300 m³/h, a 20 mA signal is transmitted to the output.
If the volume flow is 0 m³/h, a 4 mA signal is transmitted to the output.

12.5 Activation of a Pulse Output

A pulse output is an integrating output which emits a pulse when volume or mass of the medium which has passed the measuring point reaches a given value (`PULSE VALUE`). The integrated quantity is the selected physical quantity. Integration is restarted when a pulse is emitted.

Note! The menu item `PULSE OUTPUT` will be displayed in the program branch `OUTPUT OPTIONS` only if a pulse output has been installed.

```
Output Options ⬆
for Channel A:
```

Select in the program branch `OUTPUT OPTIONS` the channel for which a pulse output has to be activated. Press `ENTER`.

This display will not be indicated, if the flowmeter has only one measuring channel.

```
Pulse Output
Bl: no      >YES<
```

Select `YES` to activate the output. Press `ENTER`.

```
Pulse Output
NO COUNTING !
```

This error message will be displayed if the flow velocity is selected as physical quantity.

The use of the pulse output is not possible in this case as integration of the flow velocity does not result in a reasonable value.

```
Pulse Value
  0.01      m3
```

Enter the `PULSE VALUE`. The unit of measurement of the current physical quantity will be displayed automatically.

When the totalized physical quantity reaches the pulse value, a pulse will be emitted.

```
Pulse Width
  100      ms
```

Enter the `PULSE WIDTH`. Values between 80 ms and 1000 ms will be accepted.

The range of possible pulse widths depends on the specifications of the instrument (e.g. counter, PLC) which will be connected with the pulse output.

The max. flow that the pulse output can work with will be displayed now. This value is calculated from the data given for pulse value and pulse width.

If the flow exceeds this value, the pulse output will not function properly. In such a case, the pulse value and pulse width should be adapted to the flow conditions. Press ENTER.

12.6 Activation of an Alarm Output

Note! The menu item ALARM OUTPUT will be displayed in the program branch OUTPUT OPTIONS only if an alarm output is installed.

Max. 3 alarm outputs R1, R2, R3 per channel operating independently of each other can be configured. The alarm outputs can be used to output information on the current measurement or to start and stop pumps, motors, etc.

12.6.1 Alarm Properties

The switching condition, the holding behavior and the switching function can be defined for an alarm output:

Table 12.3: Alarm properties

alarm property	setting	description
FUNC (switching condition)	MAX	The alarm will switch when the measured value exceeds the upper limit.
	MIN	The alarm will switch when the measured value falls below the lower limit.
	+↔- -↔+	The alarm will switch when the flow direction changes (sign change of measured value).
	QUANTITY	The alarm will switch when totalizing is activated and the totalizer reaches the limit.
	ERROR	The alarm will switch when no measurement is possible.
	OFF	The alarm is switched off.
TYP (holding behavior)	NON-HOLD	If the switching condition is not true any more, the alarm returns to idle state after approx. 1 second.
	HOLD	The alarm remains activated even if the switching condition is not true anymore.
MODE (switching function)	NO CONT.	The alarm is energized when the switching condition is true and de-energized when idle. NO = normally open
	NC CONT.	The alarm is de-energized when the switching condition is true and de-energized when idle. NC = normally closed

Attention! If no measurement takes place, all alarms will be de-energized, independently of the programmed switching function.

```
Output Options  ⬆
for Channel    A:
```

Select in the program branch `OUTPUT OPTIONS` the channel for which an alarm output has to be activated. Press `ENTER`.

This display will not be indicated, if the flowmeter has only one measuring channel.

```
Alarm Output
no             >YES<
```

Select `YES` to activate the alarm output. Press `ENTER`.

```
R1=FUNC<typ mode
Function:     MAX
```

Three scroll lists will be displayed:

- `FUNC` for the switching condition
- `TYP` for the holding behavior
- `MODE` for the switching function

A scroll list will be selected in the upper line with keys `→`. A scroll list will be selected in the lower line with keys `↓`.

Press `ENTER` to store the settings.

12.6.2 Setting the Limits

If `MAX` or `MIN` has been selected in the scroll list `FUNC`, the limit of the output has to be defined:

```
R1 Input:      ⬆
Volume Flow
```

Select in the scroll list `INPUT` the physical quantity to be used for comparison. The following list items are available:

- the selected physical quantity
- signal amplitude
- sound velocity of the medium

Press `ENTER`.

Enter the limit:

table 12.4: limits MAX and MIN

switching condition	display	comparison
MAX	<pre>High Limit: -10.00 m3/h</pre>	<p>measured value > limit</p> <p>The alarm will switch when the measured value exceeds the upper limit.</p>
MIN	<pre>Low Limit: -10.00 m3/h</pre>	<p>measured value < limit</p> <p>The alarm will switch when the measured value falls below the lower limit.</p>

example 1: upper limit = $-10.0 \text{ m}^3/\text{h}$

A measured value of e.g. $-9.9 \text{ m}^3/\text{h}$ exceeds the limit. The alarm switches.

A measured value of e.g. $-11.0 \text{ m}^3/\text{h}$ does not exceed the limit. The alarm does not switch.

example 2: lower limit = $-10.0 \text{ m}^3/\text{h}$

A measured value of e.g. $-11.0 \text{ m}^3/\text{h}$ is below the limit. The alarm switches.

A measured value of e.g. $-9.9 \text{ m}^3/\text{h}$ is not below the limit. The alarm does not switch.

If **QUANTITY** has been selected in the scroll list **FUNC**, the limit of the output has to be defined:

Table 12.5: Limit of totalizer

switching condition	display	comparison
QUANTITY	<div style="border: 2px solid black; padding: 5px; display: inline-block;"> Quantity Limit: 1.00 m3 </div>	totalizer \geq limit The alarm will switch when the totalizer reaches the limit.

A positive limit will be compared to value of the totalizer for the positive flow direction.

A negative limit will be compared to value of the totalizer for the negative flow direction.

The comparison will also be made if the totalizer of the other flow direction is displayed.

Note!

The unit of measurement of the limit corresponds to the unit of measurement of the selected physical quantity.

If the unit of measurement of the physical quantity is changed, the limit has to be converted and input again.

example 1: physical quantity volume flow in m^3/h , quantity limit = 1.0 m^3

example 2: physical quantity volume flow in m^3/h , lower limit = $60.0 \text{ m}^3/\text{h}$

The unit of measurement of the physical quantity will be changed to m^3/min . The new limit to be entered is $1.0 \text{ m}^3/\text{min}$.

12.6.3 Defining the Hysteresis

A hysteresis can be defined for alarm output R1 preventing a constant triggering of the alarm by measuring values fluctuating marginally around the limit.

The hysteresis is a symmetrical range around the limit. The alarm will be activated if the measured values exceed the upper limit and deactivated if the measured values fall below the lower limit.

example: The limit is 30 m³/h and the hysteresis 1 m³/h. The alarm will be triggered at values > 30.5 m³/h deactivated at values < 29.5 m³/h.

R1 Hysterese: 1.00 m3/h

Enter the hysteresis or 0 (zero) to work without hysteresis. Press ENTER.

12.7 Behavior of the Alarm Outputs

12.7.1 Apparent Switching Delay

Measured values and totalizer values will be displayed rounded to two decimal places. The limits, however, will be compared to the non-rounded measured values. This might cause an apparent switching delay when the measured value changes marginally (less than two decimal places). In this case, the switching accuracy of the output is greater than the accuracy of the display.

12.7.2 Reset and Initialization of the Alarms

After a cold start, all alarm outputs will be initialized. They will then be in the following state:

Table 12.6: State of the output after initialization

FUNC	OFF
TYPE	NON-HOLD
MODE	NO CONT.
LIMIT	0.00

Press three times key C during measurement to set all alarm outputs to the idle state. Alarm outputs whose switching condition is still met will be reactivated after 1 second. This function is used to reset alarm outputs of type **HOLD** if the switching conditions is not met anymore.

By pressing key BRK, the measurement will be stopped and the main menu selected. All alarms outputs will be de-energized, independently of the programmed idle state.

12.7.3 Alarm Outputs during Transducer Positioning

When the positioning of the transducers begins (bar graph display), all alarms outputs switch back to the programmed idle state.

If the bar graph is selected during measurement, all alarm outputs switch back to the programmed idle state.

An alarm output of type **HOLD** being activated during the previous measurement remains in the idle state after transducer positioning if the switching condition is not anymore met.

Switching of the alarms into the idle state will not displayed.

12.7.4 Alarm Outputs during Measurement

An alarm output with switching condition **MAX** or **MIN** will be updated max. once per second to avoid humming (i.e. fluctuation of the measured values around the value of the switching condition).

An alarm output of type `NON-HOLD` will be activated if the switching condition is met. It will be deactivated if the switching condition is not met anymore. The alarm remains activated min. 1 second even if the switching condition is met shorter.

Alarm outputs with switching condition `QUANTITY` will be activated immediately when the limit is reached.

Alarm outputs with switching condition `ERROR` will be activated only after several unsuccessful measuring attempts. Therefore, typical short-term disturbances of the measurement (e.g. switching on of a pump) will not activate the alarm.

Alarm outputs with switching condition `+⇔- -⇔+` and type `NON-HOLD` will be activated with each change of the flow direction for approx. 1 second (see Fig. 12.2).

Alarm outputs with switching condition `+⇔- -⇔+` and type `HOLD` will be activated after the first change of the flow direction. They can be switched back by pressing key `C` three times (see Fig. 12.2).

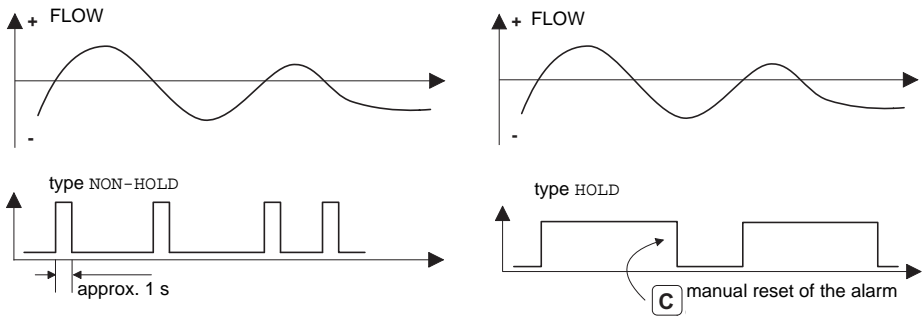

Fig. 12.2: Behavior of a relay when the flow direction changes

If there is an internal adaptation to changing measuring conditions, e.g. to a considerable rise of the medium temperature, the alarm will not switch. Alarm outputs with the switching condition `OFF` will be set automatically to the switching function `NO CONT.`

12.7.5 Alarm State Indication





Note! There is no visual or acoustic indication of alarm switching.

The state of the alarm can be displayed during measurement. This function will be activated in `SPECIAL FUNCTION\SYSTEM SETTINGS\DIALOGS\MENUS`. The setting is cold start resistant.

```
SHOW RELAIS STAT
off                >ON<
```

Select the menu item `SHOW RELAIS STAT`. Select `ON` to activate the display of the alarm state.

Scroll during measurement with key `→` until the state of alarm is displayed in the upper line.

RX =     , where  is a pictogram according to Table 12.1.





















example: R1 =    

Table 12.1: Pictograms in the display of the state of alarm

	no.	switching condition (FUNC)	holding behavior (TYPE)	switching function (MODE)	actual state
R		= 			
	1	 OFF	 NON-HOLD	 NO CONT.	 closed
	2	 MAX	 HOLD	 NC CONT.	 open
	3	 MIN			
		 + → - - → +			
		 QUANTITY			
		 ERROR			

12.8 Deactivating the Outputs

If the programmed outputs are no longer required, they can be deactivated. The configuration of the deactivated output is stored and will be available when the output is reactivated.

```
Alarm Output
>NO<          yes
```

To deactivate an output, select NO in OUTPUT OPTIONS\ALARM OUTPUT. Press ENTER.

13 Troubleshooting

If any problem appears which can not be solved with the help of this manual, contact our sales office giving a precise description of the problem. Specify the type, serial number and firmware version of the flowmeter.

Calibration

Sonalok is a very reliable instrument. It is manufactured under strict quality control, using modern production techniques. If installed as recommended in an appropriate location, used cautiously and taken care of conscientiously, no troubles should appear. The flowmeter has been calibrated at the factory and usually, a re-calibration of the flowmeter will not be necessary. A re-calibration is recommended if

- the contact surface of the transducers show visible wear or
- the transducers were used for a prolonged period at a high temperature (several months > 100 °C for normal transducers or > 200 °C for high temperature transducers).

The flowmeter has to be sent to EESIFLO for recalibration under reference conditions.

The display does not work at all or always fails

Make sure that the correct voltage is available at the terminals. The voltage is indicated on the metal plate below the outer right terminal strip. If the power supply is ok, the transducers or an internal component of the flowmeter are defective. Transducers and flowmeter have to be sent for repair to EESIFLO.

The message **SYSTEM ERROR** is displayed

Press key BRK to return to the main menu.

If the message is displayed repeatedly, note the number in the lower line. Track down the situations when the error is displayed. Contact EESIFLO.

The flowmeter does not react when key **BRK** is pressed during measurement

A program code has been defined. Press key C and enter the program code.

The backlight of the display does not light, but all other functions are available.

The backlight is defective. This problem has no influence on the other functions of the display. Send the flowmeter to EESIFLO for repair.

Date and time are wrong

The data backup battery has to be replaced. Send the flowmeter to EESIFLO.

An output does not work

Make sure that the outputs are configured correctly. Check the function of the output as described in section 12.1.3. If the output is defective, contact EESIFLO.

Measurement is impossible or the measured values substantially differ from the expected values

See section 13.1.

The totalizer values are wrong

See section 13.6.

13.1 Problems with the Measurement

A measurement is impossible as no signal is received. A question mark will be displayed at the right side of the lower line

- Make sure that the entered parameters are correct, especially the outer pipe diameter, the wall thickness and the sound velocity of the medium. (Typical errors: The circumference or the radius was entered instead of the diameter. The inner diameter was entered instead of the outer diameter.)
- Make sure that the transducer distance recommended by Sonalok was adjusted when mounting the transducers.
- Make sure that an appropriate measuring point has been selected (see section 13.2).
- Try to obtain better acoustic contact between the pipe and the transducers (see section 13.3).
- Enter a lower value for the number of sound paths. The signal attenuation might be too high due to a high medium viscosity or deposits on the inner pipe wall (see section 13.4).

The measuring signal is received but no measuring values can be obtained

- An exclamation mark "!" in the lower right edge of the display indicates that the defined upper limit of the flow velocity is exceeded and, thus, the measured values will be marked invalid. The limit has to be adapted to the measuring conditions or the check has to be deactivated (see section 9.4).
- If no exclamation mark "!" is displayed, a measurement at the selected measuring point is impossible.

Loss of signal during measurement

- If the pipe had been run empty and then has filled up again: Was there no measuring signal afterwards? Contact EESIFLO.
- Wait briefly until the acoustic contact is reestablished. The measurement can be temporarily impossible by a high proportion of gaseous or solid particles in the medium.

The measuring values substantially differ from the expected values

- Wrong measured values are often caused by wrong parameters. Make sure that the parameters entered are correct for the measuring point.
- If the parameters are correct, see section 13.5 for the description of typical situations in which wrong measured values are obtained.

13.2 Correct Selection of the Measuring Point

- Make sure that the recommended min. distance to any disturbance source is respected (see Table 4.2 in chapter 4).
- Avoid locations where deposits are building in the pipe.
- Avoid measuring points in the vicinity of deformations and defects of the pipe and in the vicinity of weldings.
- Measure the temperature at the measuring point and make sure that the transducers are appropriate for this temperature.
- Make sure that the outer pipe diameter is within the measuring range of the transducers.
- When measuring on horizontal pipes, the transducers have to be mounted to the side of the pipes.
- A pipe vertically mounted has always to be filled at the measuring point, and the medium should flow upward.
- Bubbles should be avoided (even bubble-free media can form gas pockets when the medium expands, e.g. before pumps and after great cross-section extensions).

Note!

If the temperature fluctuates at the measuring point, it is important that the inner hook of the clasp grabs in the tension strip. Otherwise, the pressure of the transducer will be insufficient when the temperature is low.

Note!

For high temperature fluctuations, it is recommended to fix the transducers with the help of EESIFLO clasps with compensating springs. Contact EESIFLO.

13.3 Maximum Acoustic Contact

Observe the points in section 7.6.2.

13.4 Application Specific Problems

The sound velocity of the medium is wrong

The entered sound velocity will be used to calculate the transducer distance and, thus, is very important for the transducer positioning. The sound velocities programmed in the flowmeter only serve as orientation values.

The entered pipe roughness is not appropriate

Reconsider the entered value, taking into account the state of the pipe.

Measurements on porous pipe materials (e.g. concrete or cast iron) are only possible under certain conditions

Contact EESIFLO.

The pipe liner may cause problems during measurement if it is not attached tightly to the inner pipe wall or consists of acoustically absorbing material

Try measuring on a liner free section of the pipe.

Media with high viscosity strongly attenuate the ultrasonic signal

Measurements on media with a viscosity $> 1000 \text{ mm}^2/\text{s}$ are only possible under certain conditions.

Higher proportions of or solids in the medium scatter and absorb ultrasounds and therefore attenuate the measuring signal

A measurements is impossible if the value is $\geq 10 \%$. If the proportion is high, but $< 10 \%$, a measurement might be possible under certain conditions.

The flow is in the transition range between laminar and turbulent flow where flow measurement is problematic.

Calculate the Reynolds number of the flow at the measuring point with the program (free download: www.eesiflo.com). Contact EESIFLO.

13.5 High Measuring Deviations

The sound velocity of the medium is wrong

A wrong sound velocity can lead to the ultrasonic signal reflected on the pipe wall being mistaken for the measuring signal passing the medium. The flow calculated from the wrong signal by the flowmeter is very small or fluctuates around zero.

The defined upper limit of the flow velocity is too low

All measured flow velocities that are greater than the upper limit will be ignored and marked as invalid. All quantities derived from the flow velocity are marked as invalid, too. If several correct measured values are ignored, the totalizer values will be too low.

The entered cut-off flow is too high

All flow velocities below the cut-off flow are set to zero. All derived values are set to zero as well. To measure at small flow velocities, the cut-off flow (default: 2.5 cm/s) must be set to an appropriate low value.

The entered pipe roughness is inappropriate

The flow velocity to be measured is outside the measuring range of the flowmeter.

The measuring point is not appropriate

Select another measuring point to check whether the results are better. The cross-section of the pipe is never perfectly circular, thus influencing the flow profile. Change the transducer position according to the pipe deformation.

13.6 Problems with the Totalizers

The totalizer values are too high

See `SPECIAL FUNCTION\SYSTEM SETTINGS\MEASURING\QUANTITY RECALL`. If this menu item is activated, the totalizer values will be stored. The totalizer will take this value at the start of the next measurement.

The totalizer values are too low

One of the totalizers has reached the upper limit and has to be reset to zero manually.

The sum of the totalizers is not correct

See `SPECIAL FUNCTION\SYSTEM SETTINGS\MEASURING\QUANT. WRAPPING`. The output sum of both totalizers is not valid after the overflow (wrapping) of one of the totalizers.

A Technical Data

Subject to modifications without prior notice.

SONALOK 7S 51/52 SERIES

Measuring

measuring principle:	ultrasonic time difference correlation principle
flow velocity:	0.01...25 m/s
resolution:	0.025 cm/s
repeatability:	0.25 % of reading \pm 0.01 m/s
accuracy:	(for fully developed, rotationally symmetrical flow profile)
- volume flow:	\pm 2 % of reading \pm 0.01 m/s*
measurable media:	all acoustically conductive fluids with < 10 % gaseous or solid content in volume

Flowmeter

	Sonalok 7S 51	Sonalok 7S 52
enclosure		
- weight:	1.5 kg	1.7 kg
- degree of protection:	IP 66 according to EN 60529	
- material:	aluminum, powder coated	
- dimensions (L x H x D) without cable glands:	180 x 140 x 71 mm	220 x 140 x 71 mm
measuring channels:	1	2
power supply:	100...240 V AC or 24 V DC	
display:	2x 16 characters, dot matrix, backlit	
operating temperature:	-10...+60 °C	
power consumption:	< 10 W	
signal damping:	0...100 s, adjustable	
measuring cycle:	100 Hz (1 channel)	
response time:	1 s (1 channel)	

Measuring functions

physical quantities:	flow velocity, volume flow, mass flow
totalizers:	volume, mass
calculation functions:	Sonalok 5200: average, difference, sum
operating languages:	English, German, French, Dutch, Spanish

* under reference conditions and $v > 0.25$ m/s

outputs

The outputs are galvanically isolated from main device.

The basic instrument is equipped with 1 current output and 2 binary outputs (Reed relay).

current	active, $R_{\text{ext}} < 500 \Omega$
- measuring range:	0/4...20 mA
- accuracy:	0.1 % of reading $\pm 15 \mu\text{A}$
binary	Reed contact: 48 V/0.25 A
as state output:	limit, sign change or error
as pulse output:	value: 0.01...1000 units
	width: 80...1000 ms

clamp-on flow transducers**type M5**

(possible) rated pipe diameter range:	(50) 100...2500 mm
dimensions:	58 x 28 x 31 mm
operating temperature (process):	-30...+100 °C
operating temperature (ambient):	-30...+100 °C
degree of protection:	IP 67 according to EN 60529

type Q5

(possible) rated pipe diameter range:	(10) 25...400 mm
dimensions:	35 x 21 x 18 mm
operating temperature (process):	-30...+100 °C
operating temperature (ambient):	-30...+100 °C
degree of protection:	IP 67 according to EN 60529

Units of measurement

operational volume flow	flow velocity	mass flow	totalizer				
			volume	mass			
m ³ /d	m/s	kg/h	m ³	g			
m ³ /h	cm/s	kg/min	l	kg			
m ³ /min	inch/s	g/s	gal	t			
m ³ /s	fps	t/d					
ml/min		t/h					
l/h		lb/d					
l/min		lb/h					
l/s		lb/min					
hl/h		lb/s					
hl/min							
hl/s							
MI/d							
bbl/d							
bbl/h							
bbl/m							
USgpd							
USgph							
USgpm							
USgps							
MGD							
CFD							
CFH							
CFM							
CFS							

1 US gallon = 3.78 barrel = 42 US gallons = 158.76 l

Flow Nomogram (metrical):

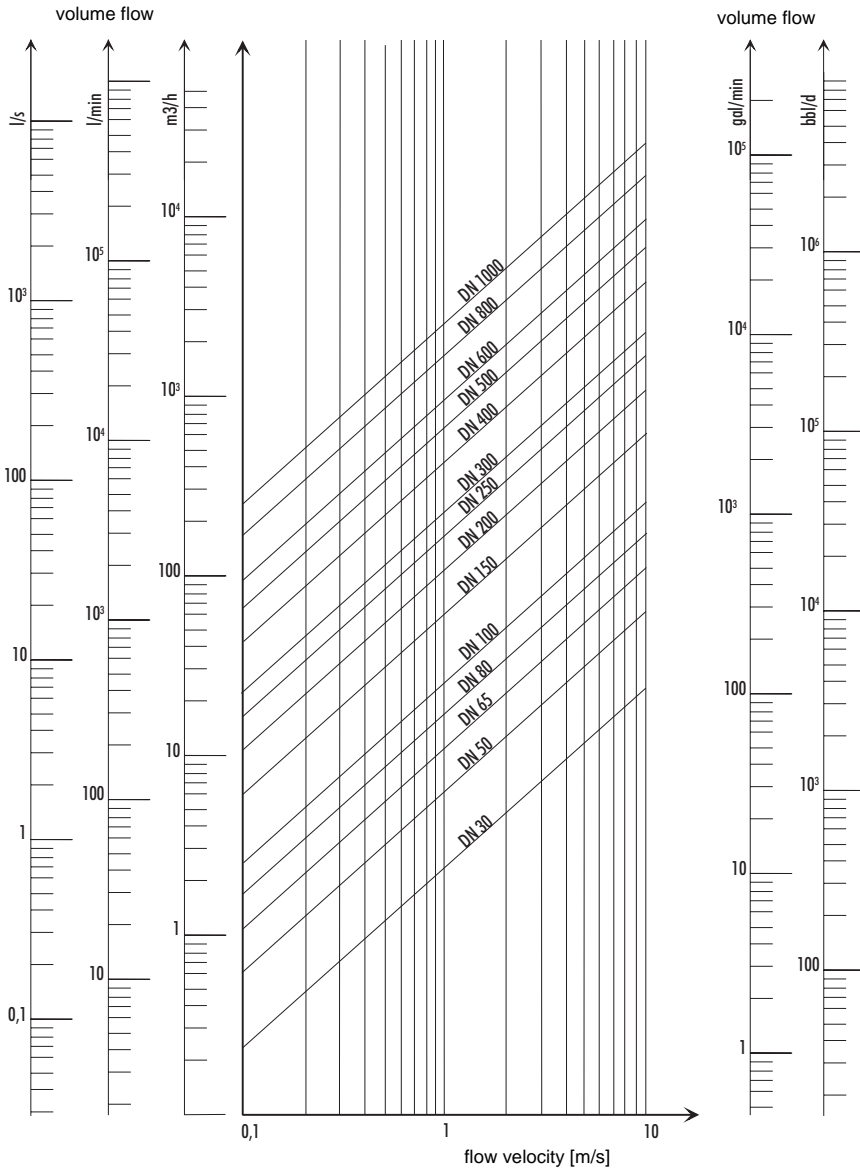

Flow Nomogram (imperial):

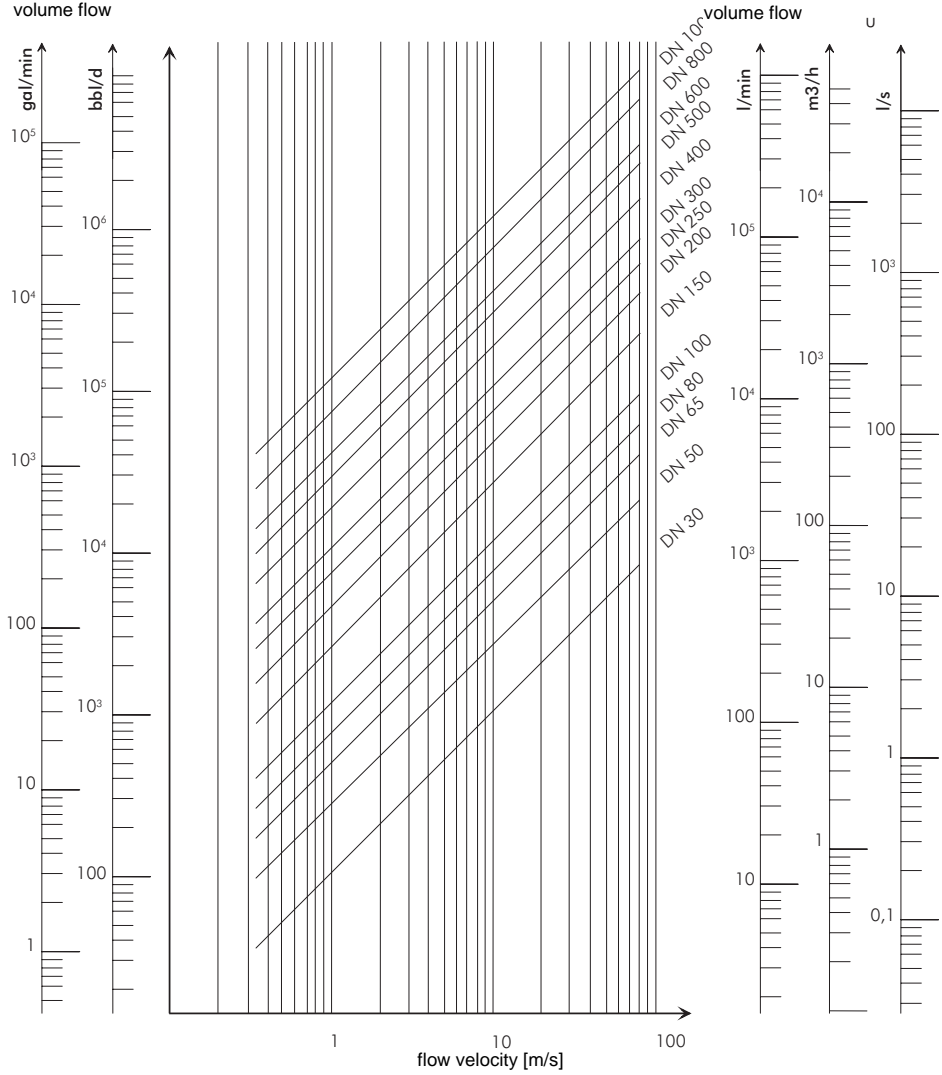

B Menu Structure

Program Branch PARAMETER

```
>PAR< mea opt sf
Parameter
```

main menu: selection of the program branch PARAMETER

```
Parameter      ↕
for Channel    A:
```

Selection of a measuring channel (A, B) or of a calculation channel (Y, Z)

This display will not be indicated, if the flowmeter has only one measuring channel.

When a measuring channel is selected (A, B):

```
Outer Diameter
  100.0      mm
```

input of the outer pipe diameter

```
Pipe Circumfer.
  314.2      mm
```

input of the pipe circumference

This display is indicated only, if PIPE_CIRCUMFER. is activated in SPECIAL_FUNCTION\SYSTEM_SETTINGS\DIALOGS/MENUS and OUTER_DIAMETER = 0 has been entered.

```
Wall Thickness
   3.0      mm
```

input of the pipe wall thickness

```
Pipe Material  ↕
Carbon Steel
```

selection of the pipe material

```
c-Material
  3230.0     m/s
```

input of the sound velocity of the pipe material

This display is indicated only if OTHER_MEDIUM has been selected.

```
Lining
no           >YES<
```

selection, whether the pipe is lined

```
lining      ↕
Bitumen
```

selection of the lining material

This display is indicated only if LINING = YES has been selected.

```
c-Material
  3200.0     m/s
```

input of the sound velocity of the lining material

This display is indicated only if OTHER_MATERIAL has been selected.

```
Liner Thickness
   3.0      mm
```

input of the liner thickness

Roughness		
0.4		mm

input of the roughness of the inner pipe wall

Medium	↕
Water	

selection of the medium

c-Medium	MIN
1400.0	m/s

input of the min. sound velocity of the medium

This display is indicated only if OTHER MEDIUM has been selected.

c-Medium	MAX
1550.0	m/s

input of the max. sound velocity of the medium

This display is indicated only if OTHER MEDIUM has been selected.

Kinem. Viscosity	
1.00	mm ² /s

input of the kinematic viscosity of the medium

This display is indicated only if OTHER MEDIUM has been selected.

Density	
1.00	g/cm ³

input of the operational density of the medium

This display is indicated only if OTHER MEDIUM has been selected.

Medium Temperat.	
20.0	C

input of the medium temperature

Additional cable	
65.0	m

input of the additional transducer cable length

When a calculation channel is selected (Y, Z):

Calculation channels are only available if the flowmeter has more than one measuring channel.

Calculation:
Y= A - B

display of the current calculation function

>CH1< funct ch2	↕
A - B	

selection of the calculation function

Program Branch MEASURING

```
par >MEA< opt sf
Measuring
```

main menu: selection of the program branch MEASURING

```
KANAL: >A< B Y Z
MESSEN  ✓  ✓  -  .
```

activation of the channels

This display will not be indicated, if the flowmeter has only one measuring channel.

```
Transd. Distance
A:54 mm Reflec
```

display of the transducer distance to be adjusted between the inner edges of the transducers

Program Branch OUTPUT OPTIONS

```
par mea >OPT< sf
Output Options
```

main menu: selection of the program branch OUTPUT OPTIONS

```
Output Options ⇅
for Channel   A:
```

selection of the channel whose output options are to be defined

```
Physic. Quant. ⇅
Volume Flow
```

selection of the physical quantity

```
Volume in   ⇅
m3/h
```

selection of the unit of measurement for the physical quantity

```
Damping
      10      s
```

input of the duration over which a floating average of the measured values has to be determined

CURRENT LOOP

```
Current Loop
I1: no      >YES<
```

activation of a current output

This display is indicated only if the current output has been installed in SPECIAL FUNCTION\SYSTEM SETTINGS\PROC. OUTPUTS.

```
Meas.Values
>ABSOLUT<   sign
```

selection whether the sign of the measured values is to be considered for the output

This display is indicated only if CURRENT LOOP has been activated.

```
Zero-Scale Val.
0.00      m3/h
```

input of the lowest/highest measured value to be expected for the current output. This value will be assigned to the lower/upper limit of the output range.

These displays are indicated only if CURRENT LOOP has been activated.

```
Full-Scale Val.
300.00    m3/h
```

```
Error-val. delay
10        s
```

input of the error value delay, i.e. of the time interval after which the value entered for the error output will be transmitted to the output if no valid measured values are available

This display is indicated only if ERROR-VAL. DELAY is activated (= EDIT) in SPECIAL FUNCTION\SYSTEM SETTINGS\DIALOGS/MENUS.

PULSE OUTPUT

```
Pulse Output
B1: no      >YES<
```

activation of a pulse output

This display is indicated only if a pulse output has been installed in SPECIAL FUNCTION\SYSTEM SETTINGS\PROC. OUTPUTS.

```
Pulse Value
0.01      m3
```

input of the pulse value (value of the totalizer at which a pulse will be emitted)

This display is indicated only if PULSE OUTPUT has been activated.

```
Pulse Width
100      ms
```

input of the pulse width

This display is indicated only if PULSE OUTPUT has been activated.

ALARM OUTPUT

Alarm Output
no >YES<

activation of an alarm output

This display is indicated only if an alarm output has been installed in SPECIAL FUNCTION\SYSTEM SETTINGS\PROC. OUTPUTS.

R1=FUNC<typ mode
Function: MAX

selection of the switching condition (FUNC), of the holding behavior (TYP) and of the switching function (MODE) of the alarm output

This display only is indicated if ALARM OUTPUT has been activated.

R1 Input: ⬆
Volume Flow

selection of the physical quantity to be monitored

This display only is indicated only for R1 if an ALARM OUTPUT is activated.

High Limit:
-10.00 m3/h

input of the upper limit of the physical quantity to be monitored

This display is indicated only if ALARM OUTPUT has been activated and MAX has been selected as switching condition.

Low Limit:
-10.00 m3/h

input of the lower limit of the physical quantity to be monitored

This display is indicated only if ALARM OUTPUT has been activated and MIN has been selected as switching condition.

Quantity Limit:
1.00 m3

input of the limit for the totalizer of the physical quantity to be monitored

This display is indicated only if ALARM OUTPUT has been activated and QUANTITY has been selected as switching condition.

R1 Hysterese:
1.00 m3/h

input of the hysteresis for the lower or upper limit

This display is indicated only if ALARM OUTPUT has been activated and MIN or MAX has been selected as switching condition.

Program Branch SPECIAL FUNCTION

```
par mea opt >SF<
Special Function
```

main menu: selection of the program branch SPECIAL FUNCTION

SYSTEM SETTINGS

```
Special Funct. ⬆
SYSTEM settings
```

selection of SPECIAL FUNCTION\SYSTEM SETTINGS

SYSTEM SETTINGS\SET CLOCK

```
SYSTEM settings ⬆
Set Clock
```

selection of the displays for the input of date and time

SYSTEM SETTINGS\DIALOGS/MENUS

```
SYSTEM settings ⬆
Dialogs/Menu
```

selection of the displays for activation/deactivation or setting of menu items in the other program branches

```
Pipe Circumfer.
off >ON<
```

activation of the menu item for the input of the pipe circumference in the program branch PARAMETER

```
Transd. Distance
auto >USER<
```

setting for the display for the input of the transducer distance in the program branch MEASURING:

- USER: only the entered transducer distance will be displayed if the recommended and the entered transducer distances are identical
- AUTO: only the recommended transducer distance will be displayed

recommended setting: USER

```
Error-val. delay
damping >EDIT<
```

selection of the error value delay

- DAMPING: the damping value will be used.
- EDIT: The menu item for the input of the error value delay in the program branch OUTPUT OPTIONS will be activated.

```
SHOW RELAIS STAT
off >ON<
```

activation of the indication of the alarm state during measurement

SYSTEM SETTINGS\MEASURING

SYSTEM settings ⬆
Measuring

selection of the displays for the settings of the measurement

Cut-off Flow
absolut >SIGN<

selection of the input of a lower limit for the flow velocity.

- ABSOLUT: independent of the flow direction
- SIGN: dependent on the flow direction

Cut-off Flow
factory >USER<

activation of the input of a lower limit of the flow velocity:

- FACTORY: the default limit of 2.5 cm/s will be used
- USER: input of a limit

+Cut-off Flow
2.5 cm/s

input of the cut-off flow for positive measured values

This display is indicated only if CUT-OFF FLOW\SIGN and USER have been selected before.

-Cut-off Flow
-2.5 cm/s

input of the cut-off flow for negative measured values

This display is indicated only if CUT-OFF FLOW\SIGN and USER have been selected before.

Cut-off Flow
2.5 cm/s

input of the cut-off flow for the absolute value of the measured values

This display is indicated only if CUT-OFF FLOW\ABSOLUT and USER have been selected before.

Velocity limit
0.0 m/s

input of an upper limit of the flow velocity

All measured values exceeding the limit will be marked as outliers.

Input of 0 (zero) switches off the detection of outliers.

Quant. wrapping
off >ON<

activation of the overflow of the totalizers

Quantity recall
off >ON<

activation of the taking over of the totalizer values after re-start of the measurement

SYSTEM SETTINGS\PROC. OUTPUTS

SYSTEM-settings ⬆
Proc. outputs

selection of the displays for the setting of the outputs of the flowmeter

Install Output ⬆
Current I1

selection of the output to be installed

SYSTEM SETTINGS\MISCELLANEOUS

SYSTEM settings ⬆ Miscellaneous	selection of the display for the setting of the contrast
------------------------------------	--

SETUP DISPLAY ← CONTRAST →	setting of the contrast of the display
-------------------------------	--

Input a HOTCODE no >YES<	confirmation that a HotCode has to be entered
-----------------------------	---

Please input a HOTCODE: 000000	input of a HotCode
-----------------------------------	--------------------

INSTRUM. INFORM.

Special Funct. ⬆ Instrum. Inform.	selection of the displays for the information about the flow-meter
--------------------------------------	--

5X00-25X00100 V x.xx dd.mm.yy	display of type, serial number and firmware version with date (dd - day, mm - month, yy - year)
----------------------------------	---

PROGRAMMIER-CODE

Special Funct. ⬆ Set program code	selection of the displays for input of a program code
--------------------------------------	---

Program Code -----	input of the program code
-----------------------	---------------------------

INPUT BREAK_CODE CODE: 000000	input of the break code (= program code)
----------------------------------	--

INP. ACCESS CODE CODE: 000000	input of the access code (= the first three digits of the program code)
----------------------------------	---

C Reference

The following tables provide assistance for the user. The accuracy of the data depends on the composition, the temperature and the manufacturing process of the material. EESIFLO does not assume liability for any inaccuracies.

Table C.1: Sound Velocity of Selected Pipe and Lining Materials at 20 °C

The values of some of these materials are stored in the internal database of Sonalok. In the column c_{flow} , the sound velocity (longitudinal or transversal) used for flow measurement is indicated.

Material	c_{trans} [m/s]	c_{long} [m/s]	c_{flow}	Material	c_{trans} [m/s]	c_{long} [m/s]	c_{flow}
aluminum	3100	6300	trans	platinum	1670		trans
asbestos cement	2200		trans	polyethylene	925		trans
lead	700	2200	trans	polystyrene	1150		trans
bitumen	2500		trans	PP	2600		trans
brass	2100	4300	trans	PVC		2395	long
carbon steel	3230	5800	trans	PVC (hard)	948		trans
copper	2260	4700	trans	PVDF	760	2050	long
Cu-Ni-Fe	2510		trans	quartz glass	3515		trans
ductile iron	2650		trans	rubber	1900	2400	trans
glass	3400	4700	trans	silver	1590		trans
grey cast iron	2650	4600	long	Sintimid		2472	long
PE		1950	long	stainless steel	3230	5790	trans
Perspex	1250	2730	long	Teka PEEK		2537	long
PFA		1185	long	Tekason		2230	long
plastics	1120	2000	long	titanium	3067	5955	trans

Take into consideration for the measuring task that the sound velocity depends on the composition and the processing of the material.

The sound velocity of alloys and cast materials will fluctuate over a certain range. The values give a rough orientation.

Table C.2: Typical Roughness Coefficients of Pipes

The values are based on experience and measurements.

material	absolute roughness [mm]
drawn pipes of non-ferrous metal, glass, plastics and light metal	0...0.0015
drawn steel pipes	0.01...0.05
fine-planed, polished surface	max. 0.01
planed surface	0.01...0.04
rough-planed surface	0.05...0.1
welded steel pipes, new	0.05...0.1
long usage, cleaned	0.15...0.2
lightly and evenly rusted	max. 0.4
heavily encrusted	max. 3
cast iron pipes:	
bitumen lining	> 0.12
new, without lining	0.25...1
rusted	1...1.5
encrusted	1.5...3

Table C.3: Properties of Water at 1 bar and at Saturation Pressure

medium temperature [°C]	medium pressure [bar]	density [kg/m ³]	specific heat* [kJ/kg/K ⁻¹]
0	1	999.8	4.218
10	1	999.7	4.192
20	1	998.3	4.182
30	1	995.7	4.178
40	1	992.3	4.178
50	1	988.0	4.181
60	1	983.2	4.184
70	1	977.7	4.190
80	1	971.6	4.196
90	1	965.2	4.205
100	1.013	958.1	4.216
120	1.985	942.9	4.245
140	3.614	925.8	4.285
160	6.181	907.3	4.339
180	10.027	886.9	4.408
200	15.55	864.7	4.497
220	23.20	840.3	4.613
240	33.48	813.6	4.769
260	46.94	784.0	4.983
280	64.20	750.5	5.290
300	85.93	712.2	5.762
320	112.89	666.9	6.565
340	146.05	610.2	8.233
360	186.75	527.5	14.58
374.15	221.20	315.5	∞

* at constant pressure

Table C.4: Chemical Resistance of Autotex

Autotex (keyboard) is resistant according to DIN 42115, part 2 against following chemicals for a contact time of more than 24 hours without visible modification:

- ethanol
- cyclohexanol
- diacetone alcohol
- glycol
- isopropanol
- glycerine
- methanol
- triacetin
- Dowandol DRM/PM
- acetone
- methyl-ethyl-ketone
- Dioxan
- cyclohexanone
- MIBK
- isophorone
- ammonia <40 %
- soda lye <40 %
- potassium hydroxide <30 %
- alcalicarbonat
- bichromate
- potassium hexacyanoferrates
- acetonitrile
- sodium bisulfate
- formaldehyde 37...42%
- acetaldehyde
- aliphatic hydrocarbons
- Toluol
- Xylol
- diluent (white spirit)
- formic acid <50 %
- acetic acid <50 %
- phosphoric acid <30 %
- hydrochloric acid <36 %
- nitric acid <10 %
- trichloroacetic acid <50 %
- sulphuric acid <10 %
- drilling emulsion
- diesel oil
- varnish
- paraffin oil
- castor oil
- silicone oil
- turpentine oil substitute
- Dccon
- plane fuel
- gasoline
- water
- saltwater
- 1,1,1-trichlorethane
- ethyl acetate
- diethyl ether
- N-butyl acetate
- amyl acetate
- butylcellosolve
- ether
- chlornatron <20 %
- hydrogen peroxide <25 %
- potash soft soap
- detergent
- tensides
- softener
- iron chloride (FeCl₂)
- iron chloride (FeCl₃)
- dibutyl phthalate
- dioctyl phthalate
- sodium carbonate

Autotex is resistant according to DIN 42115, part 2 to acetic acid for a contact time <1 hour without visible damage.

Autotex is not resistant to following chemicals:

- concentrated mineral acids
- concentrated alkaline solutions
- high pressure steam >100 °C
- benzyl alcohol
- methylene chloride